

AP5TC

User's Guide

Printed in Taiwan

PART NO.: 49.87907.001

DOC. NO. : AP5TC-1-E9801A

AP5TC

Mainboard

User's Guide

Document Number : AP5TC-1-E9801A
Model and Revision : For AP5TC revision 1.xx
Manual Version : English, revision A
Release Date : Jan 9, 1998

More help for latest information:

Taiwan <http://www.aopen.com.tw>
USA <http://www.aopen-usa.com>
<http://www.aopenamerica.com>
Europe <http://www.aopen.nl>

Copyright

Copyright © 1998 by this company. All rights reserved. No part of this publication may be reproduced, transmitted, transcribed, stored in a retrieval system, or translated into any language or computer language, in any form or by any means, electronic, mechanical, magnetic, optical, manual or otherwise, without the prior written permission of this company.

Disclaimer

This company makes no representations or warranties, either expressed or implied, with respect to the contents hereof and specifically disclaims any warranties, merchantability or fitness for any particular purpose. Any software described in this manual is sold or licensed "as is". Should the programs prove defective following their purchase, the buyer (and not this company, its distributor, or its dealer) assumes the entire cost of all necessary servicing, repair, and any incidental or consequential damages resulting from any defect in the software. Further, this company reserves the right to revise this publication and to make changes from time to time in the contents hereof without obligation to notify any person of such revision or changes.

Intel and Pentium are registered trademarks of Intel Corporation.

XT/AT is a registered trademark of International Business Machines Corporation.

AMI is a registered trademark of American Megatrends Inc.

AWARD is a registered trademark of Award Software Inc.

Other brand and product names are trademarks and/or registered trademarks of their respective holders.

Organization

Chapter 1, **Overview**, covers the introduction and specifications of the system board.

Chapter 2, **Hardware Installation**, describes hardware jumpers, connectors and memory configuration. There are user friendly drawings to locate jumper and connector.

Chapter 3, **AWARD BIOS**, explains the system BIOS and tells how to configure the system by setting the BIOS parameters.

Appendix A, **Frequently Asked Question**, collects most frequently asked question of this product.

Appendix B, **Troubleshooting Guide**, includes first aid information you need if you meet trouble, the WWW address and worldwide service telephone/fax are also included.

Appendix C, **Jumper Table Summary**, gives you a tabular summary of the jumper settings discussed in Chapter 2.

Conventions

The following conventions are used in this manual:

Text entered by user,
default settings,
recommended selections

Represent text input by the user,
default settings and recommended
selections

<Enter>, <Tab>,<Ctl>, <Alt>,
<Ins>, , etc

Represent the actual keys that you
have to press on the keyboard.



Note:

Gives bits and pieces of additional
information related to the current topic.



Warning:

Alerts you to any damage that might
result from doing or not doing specific
actions.



Caution:

Suggests precautionary measures to
avoid potential hardware or software
problems.



Important:

Reminds you to take specific action
relevant to the accomplishment of the
procedure at hand.



Tip:

Tells how to accomplish a procedure
with minimum steps through little
shortcuts.

Contents

CHAPTER 1 OVERVIEW

1.1 SPECIFICATIONS	3
1.2 SUSPEND TO HARD DRIVE	5
1.3 CPU THERMAL PROTECTION	8
1.4 PCI SOUND CARD CONNECTOR.....	9

CHAPTER 2 HARDWARE INSTALLATION

2.1 JUMPERS AND CONNECTOR LOCATIONS	2
2.2 JUMPERS	4
2.2.1 Setting the CPU Voltage	5
2.2.2 Selecting the CPU Frequency	8
2.2.3 Clearing the CMOS	12
2.3 CONNECTORS	13
2.3.1 Power Cable.....	13
2.3.2 CPU Fan.....	14
2.3.3 PS/2 Mouse.....	14
2.3.4 Serial Devices (COM1/COM2)	15
2.3.5 USB Device (optional).....	15
2.3.6 Floppy Drive	16
2.3.7 Printer.....	16
2.3.8 IDE Hard Disk and CD ROM.....	17
2.3.9 Hard Disk LED	18
2.3.10 Panel Connector.....	19
2.3.11 Keyboard	20
2.3.12 IrDA Connector	21
2.3.13 SB-LINK	22
2.4 INSTALLING THE SYSTEM MEMORY.....	23

CHAPTER 3 AWARD BIOS

3.1 ENTERING THE AWARD BIOS SETUP MENU	2
3.2 STANDARD CMOS SETUP	3
3.3 BIOS FEATURES SETUP	6
3.4 CHIPSET FEATURES SETUP.....	11
3.5 POWER MANAGEMENT SETUP.....	17

3.6 PNP/PCI CONFIGURATION SETUP	22
3.7 LOAD SETUP DEFAULTS	26
3.8 LOAD TURBO DEFAULTS.....	26
3.9 INTEGRATED PERIPHERALS.....	27
3.10 PASSWORD SETTING	32
3.11 IDE HDD AUTO DETECTION	32
3.12 SAVE & EXIT SETUP	32
3.13 EXIT WITHOUT SAVING	33
3.14 NCR SCSI BIOS AND DRIVERS	33
3.15 BIOS FLASH UTILITY.....	34

APPENDIX A FREQUENTLY ASKED QUESTION

APPENDIX B TROUBLESHOOTING

APPENDIX C JUMPER TABLE SUMMARY

Chapter 1

Overview

The AP5TC is a high-performance Pentium®-based system board that utilizes the PCI/ISA architecture and **Baby AT** form factor. It integrates the Intel **82430TX** PCIset, a Super I/O controller, and a PCI mode 4 enhanced IDE controller with bus master and **Ultra DMA/33** to enhance system performance. It has **512KB** pipelined-burst second-level **cache onboard** and support four single in-line memory module (SIMM) plus two Dual in-line memory module (DIMM) that allow to **mix EDO and SDRAM** memory and expansion up to a maximum of 256MB. For the memory and IDE performance, the Intel 430TX chipset is currently the **fastest Pentium chipset** in the market.

In addition, AP5TC also implements many special features as following.

Switching Power Regulator Although Linear Regulator is good enough for AMD K6, AP5TC uses switching regulator to reserve the upgrade capability for new generation CPU.

Over-current Protection AP5TC implements CPU core voltage 15A over-current protection to prevent any accident short circuit and prevent system damage.

CPU Thermal Protection When CPU temperature is higher than a predefined value, the CPU speed will automatically slow down and there will be warning from BIOS and also ADM (AOpen Desktop Manager, similar as Intel LDCM), if ADM is installed.

Full-range CPU core voltage This motherboard supports the CPU core voltage from 1.3V to 3.5V, that can be applied to various CPU type in future.

Resetable Fuse AP5TC implements resetable fuses to prevent any accidental short circuit caused by keyboard or USB devices hot plug.

PCI Sound Card connector The SB-LINK connector can be used to link Creative-compatible PCI sound card. If you have a Creative PCI sound card installed, it is necessary to link the card to this connector for compatibility issue under DOS environment.

Overview

FCC DoC certificate The AP5TC has also passed **FCC DoC test**, this means you can use any kind of housing with very low EMI radiation.

Powerful utility softwares supported AOpen Bonus Pack bundled CD contains many useful utilities, such as ADM (Advanced Desktop Manager), AOchip, Hardware Monitor utility, AcePhone, EasyAxess, Suspend to Hard Drive utility, and BIOS flash utility.

1.1 Specifications

Form Factor	Baby AT
Board Size	220 mm x 250 mm
CPU	Intel Pentium Processor P54C, PP/MT (P55C), AMD K5/K6, Cyrix 6x86 and IDT C6.
System Memory	FPM (Fast Page Mode) or EDO (Extended Data Output) 72-pin SIMM x4, and SDRAM 168-pin x2 maximum 256MB.
Second-level Cache	256KB or 512KB pipelined-burst cache onboard.
Chipset	Intel 82430TX PCIset
Expansion Slots	ISA x3 and PCI x4
Serial Port	Two serial ports UART 16C550 compatible, and the 3rd UART for IR function.
Parallel Port	One parallel port supports standard parallel port (SPP), enhanced parallel port (EPP) or extended capabilities port (ECP).
Floppy Interface	Floppy interface supports 3.5 inches drives with 720KB, 1.44MB or 2.88MB format or 5.25 inches drives with 360KB, 1.2MB format.
IDE Interface	Dual-channel IDE interface support maximum 4 IDE hard disks or CDROM, mode 4 , bus master hard disk drives and Ultra DMA/33 mode hard drives are also supported.
USB Interface	Two USB ports supported by USB bracket, the BIOS also supports USB driver to simulate legacy keyboard.
PS/2 Mouse	PS/2 mouse supported by PS/2 mouse bracket.
Keyboard	Default AT compatible keyboard, mini-DIN PS/2 keyboard connector is optional.
RTC and Battery	RTC build in Intel PIIX4 chipset, Lithium (CR-2032) battery.
BIOS	AWARD Plug-and-Play Flash ROM BIOS

Overview

Suspend to Hard Drive	Supported by BIOS, save your work to hard disk and resume within a very short time. VESA compatible VGA and Sound Blaster compatible sound card required.
Switching Regulator	High efficient switching regulator for future CPU.
Over-current Protection	CPU core voltage 15A over-current protection to prevent any accident short circuit.
CPU Thermal Protection	Warning when CPU temperature is higher than the predefined value.
SB-LINK connector supported	The SB-LINK connector can be used to link Creative PCI sound card.

1.2 Suspend to Hard Drive

Suspend to Hard Drive saves your current work (system status, memory and screen image) into hard disk, and then the system can be totally power off. Next time, when power is on, you can resume your original work directly from hard disk within few second without go through the Win95 booting process and run your application again. If your memory is 16MB, normally, you need to reserve at least 16MB HDD space to save your memory image. Note that you have to use VESA compatible PCI VGA (AOpen PV70/PT70), Sound Blaster compatible sound card and sound driver that supports APM (AOpen AW35 or MP56) for Suspend to Hard Drive to work properly. Of course, we recommend to use AOpen products for best compatibility.

Although Suspend to Hard Drive is so powerful, it is actually a little complicated to set up this function. To use Suspend to Hard Drive, please make sure you have read the following in detail.

1. Go into BIOS setup, Power Management à Suspend Mode Option, select "Suspend to Disk".
2. Go into BIOS setup, PNP/PCI Configuration à PnP OS Installed, select "No". This can give BIOS the capability to allocate system resources for Suspend to Hard Drive.
3. Bootup your system into DOS command prompt. If you are Win'95 user, Please restart your Windows 95 under "Command Prompt" by pressing "F8" while system shows "Windows 95 Starting ...". Choose "Safe Mode Command Prompt Only" from selection so that system will start in DOS command prompt.
4. Copy AOZVHDD.EXE to the root directory of your C: drive.
5. **Option 1: Use /file switch (applied to FAT16 file system):**

Please use following command to create a hidden file in the root directory of your hard disk for Suspend to Hard Drive to save the system status and memory image.

```
C:>AOZVHDD /c /file
```

Please make sure that you have enough continuous HDD space for creating this hidden file. For example, if you have 32MB of system memory and 4MB of VGA memory, you need at least 36MB (32MB + 4MB) of continuous HDD space. If AOZVHDD failed to allocate the HDD space, you may run "DEFRAG" Utility or "Disk Defragmenter" which come with MS-DOS or Win'95 to free HDD space.

Overview

Option2: Use /partiton switch (applied to FAT16/FAT32 file system):

To create a separate partiton for Suspend to Hard Drive, please make sure you have allocated a free partiton. We suggest you reserve the free partiton which space is appropriate for your future memory expansion. For example, if you have 32MB of system memory and 4MB of VGA memory currently, but you plan to upgrade system memory to 64MB in the near future, then you may reserve a 68MB (64MB+4MB) space by using a disk utility (such as fdisk). Next, use following command to create a suspend partiton:

```
C:>AOZVHDD /c /partiton
```

If there is no extra free partiton and you don't want your data lost, please do not use this partiton method.

6. After creating above partiton or hidden file, please reboot your system.
7. Push suspend switch (momentary mode) or use Win95 Suspend icon to force system goes into Suspend to Hard Drive mode and then turn system power off by power switch of your power supply.
8. Next time when you turn on your system, it will resume to your original work automatically.



Warning: Note that Intel Bus Master and Ultra DMA/33 IDE driver are not fully compatible with Suspend to Hard Drive function, installing these drivers may cause the system unstable. Under this situation, please uninstall the drivers.

Warning: This function does not support SCSI hard disks.



Tip: Following VGA card have been tested & recognized as VESA compatible VGA device.

AOpen PV90 (Trident 9680)

AOpen PT60 (S3 Virge/BIOS R1.00-01)

AOpen PV60 (S3 Tiro64V+)

AOpen PT70 (S3 Virge/DX)

ProLink Trident GD-5440

ProLink Cirrus GD-5430

ProLink Cirrus GD-5446

ATI Mach 64 GX

ATI 3D RAGE II

Diamond Stealth64D (S3 868)

Diamond Stealth64V (S3 968)

KuoWei ET-6000.



Tip: Following Sound card have been tested OK for Suspend to Hard Drive.

AOpen AW32

AOpen AW35

AOpen MP56

Creative SB 16 Value PnP

Creative SB AWE32 PnP

ESS 1868 PnP

If your sound card can not work after resume from Suspend to Hard Drive, check your sound card vendor see if there is driver to support APM, and install it again.



Note: The USB function has not been tested for Suspend to Hard Drive. If you find any unstable problem, please go into BIOS, Integrated Peripherals à USB Legacy Support. Disable the USB Legacy function.

Overview

1.3 CPU Thermal Protection

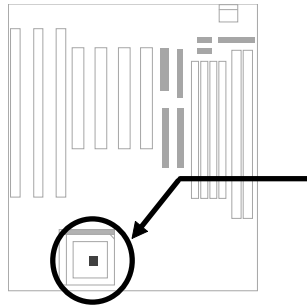

This motherboard implements special thermal protection circuit below the CPU. When temperature is higher than a predefined value, the CPU speed will automatically slow down and there will be warning from BIOS and also ADM (AOpen Desktop Manager, similar as Intel LDCM) or Hardware Monitor utility software.

ADM is a very powerful network and hardware monitor software. If you do not need network monitor function, you may also use Hardware Monitor utility, which is a small utility for hardware monitoring. Both ADM and Hardware Monitor utility are available on the bundled CD and our web site (<http://www.aopen.com.tw>).

CPU Thermal Protection is automatically implemented by BIOS and utility software, no hardware installation is needed.

1.4 PCI Sound Card connector

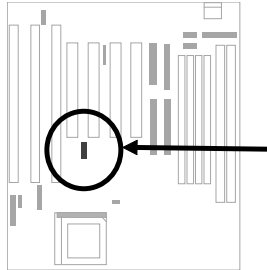

AP5TC implements a SB-LINK connector to support Creative-compatible PCI sound card. If you have a Creative-compatible PCI sound card installed, it is necessary to link the card to SB-LINK connector for compatibility issue under DOS environment.

Chapter 2

Hardware Installation

This chapter gives you a step-by-step procedure on how to install your system. Follow each section accordingly.



Caution: *Electrostatic discharge (ESD) can damage your processor, disk drives, expansion boards, and other components. Always observe the following precautions before you install a system component.*

1. *Do not remove a component from its protective packaging until you are ready to install it.*
2. *Wear a wrist ground strap and attach it to a metal part of the system unit before handling a component. If a wrist strap is not available, maintain contact with the system unit throughout any procedure requiring ESD protection.*

Hardware Installation

2.1 Jumpers and Connector Locations

The following figure shows the locations of the jumpers and connectors on the system board:

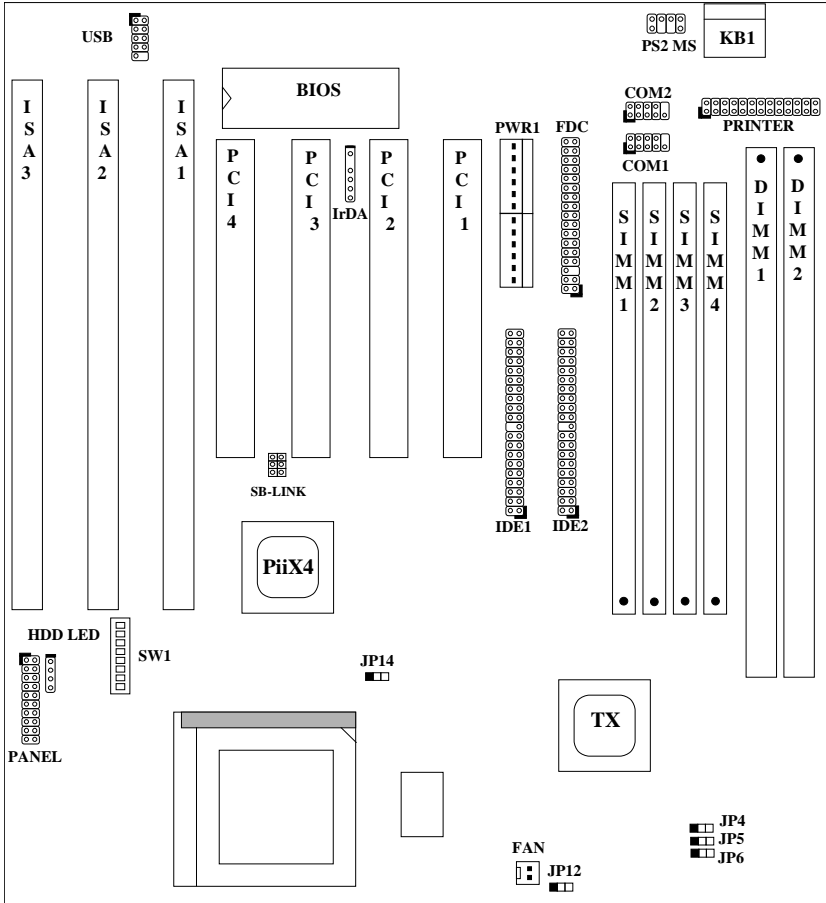

Jumpers

SW1:	DIP Switch for CPU voltage and clock ratio
JP4,JP5,JP6:	CPU external (bus) clock
JP12:	I/O Voltage
JP14:	Clear CMOS

Connectors

KB1:	AT keyboard connector
PWR1:	AT (PS/2) power connector
PS2 MS:	PS/2 mouse connector
USB:	USB connector
COM1:	COM1 connector
COM2:	COM2 connector
FDC:	Floppy drive connector
PRINTER:	Printer connector
IDE1:	IDE1 primary channel
IDE2:	IDE2 secondary channel
FAN:	CPU fan connector
IrDA:	IrDA (Infrared) connector
HDD LED:	HDD LED connector
PANEL:	Front panel (Multifunction) connector
SB-LINK:	Creative PCI sound card connector

Hardware Installation

2.2 Jumpers

Jumpers are made by pin headers and plastic connecting caps for the purpose of customizing your hardware. Doing so requires basic knowledge of computer hardware, be sure you understand the meaning of the jumpers before you change any setting. The onboard jumpers are normally set to their default with optimized settings.

On the mainboard, normally there is a bold line marked beside pin 1 of the jumper, sometimes, there are numbers also. If we connect (short) plastic cap to pin 1 and 2, we will say set it at 1-2, and when we say jumper is open, that means no plastic cap connected to jumper pins.



Open



Short



Jumper set at 1-2



Jumper set at 2-3

2.2.1 Setting the CPU Voltage

S4	S5	S6	S7	S8	Vcore
ON	ON	ON	ON	OFF	3.52V
OFF	ON	ON	ON	OFF	3.45V
OFF	OFF	ON	ON	OFF	3.2V
ON	OFF	OFF	ON	OFF	2.9V
OFF	OFF	OFF	ON	OFF	2.8V
OFF	ON	OFF	OFF	OFF	2.2V
OFF	ON	OFF	ON	ON	1.8V

SW1 is used to select CPU core voltage (Vcore) and ratio, there are totally eight switches on the DIP. After installing a CPU, remember to set the switch 4-8 to specify a proper Vcore.

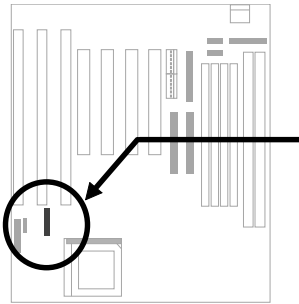

2.9V

K6-166/200 or M2

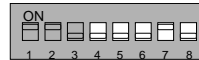

2.8V

Intel P55C (MMX)

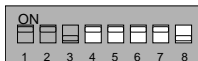

3.52V

Cyrix 6x86 or AMD K5



3.45V

Intel P54C or IDT C6



2.2V

K6-266/300



1.8V

Reserved for future use



3.2V

AMD K6-233

Hardware Installation



Warning: Please make sure that you have installed CPU fan properly if Intel PP/MT-233 or AMD K6 CPU is being selected to use. It may cause your system unstable if you can not meet the heat dissipation requirement from above CPU type. It is recommended to adopt larger fan on these CPU for better air flow in the system. Please refer to AOpen 's web site (<http://www.aopen.com.tw>) to choose a proper CPU fan.



Tip: Normally, for single voltage CPU, Vcpuio (CPU I/O Voltage) is equal to Vcore, but for CPU that needs dual voltage such as PP/MT (P55C) or Cyrix 6x86L, Vcpuio is different from Vcore and must be set to Vio (PBRAM and Chipset Voltage). The single or dual voltage CPU is automatically detected by hardware circuit.

Tip: For supporting more different CPUs in future, this motherboard uses five switches to specify Vcore. There are 32 settings totally, and the range is from 1.3V to 3.5V.

CPU	Type	S4	S5	S6	S7	S8	Vcore
INTEL P54C	Single Voltage	OFF	ON	ON	ON	OFF	3.45V
INTEL MMX P55C	Dual Voltage	OFF	OFF	OFF	ON	OFF	2.8V
AMD K5	Single Voltage	ON	ON	ON	ON	OFF	3.52V
AMD K6-166/200	Dual Voltage	ON	OFF	OFF	ON	OFF	2.9V
AMD K6-233	Dual Voltage	OFF	OFF	ON	ON	OFF	3.2V
AMD K6-266/300	Dual Voltage	OFF	ON	OFF	OFF	OFF	2.2V
Cyrix 6x86	Single Voltage	ON	ON	ON	ON	OFF	3.52V
Cyrix 6x86L	Dual Voltage	OFF	OFF	OFF	ON	OFF	2.8V
Cyrix M2	Dual Voltage	ON	OFF	OFF	ON	OFF	2.9V
IDT C6	Single Voltage	OFF	ON	ON	ON	OFF	3.45V

Hardware Installation

This motherboard supports the CPU core voltage from 1.3V to 3.5V, that can be applied to the various CPU type in future. For your reference, all settings are listed in the following table.

<u>Vcore</u>	<u>S4</u>	<u>S5</u>	<u>S6</u>	<u>S7</u>	<u>S8</u>
1.30V	OFF	OFF	OFF	OFF	ON
1.35V	ON	OFF	OFF	OFF	ON
1.40V	OFF	ON	OFF	OFF	ON
1.45V	ON	ON	OFF	OFF	ON
1.50V	OFF	OFF	ON	OFF	ON
1.55V	ON	OFF	ON	OFF	ON
1.60V	OFF	ON	ON	OFF	ON
1.65V	ON	ON	ON	OFF	ON
1.70V	OFF	OFF	OFF	ON	ON
1.75V	ON	OFF	OFF	ON	ON
1.80V	OFF	ON	OFF	ON	ON
1.85V	ON	ON	OFF	ON	ON
1.90V	OFF	OFF	ON	ON	ON
1.95V	ON	OFF	ON	ON	ON
2.00V	OFF	ON	ON	ON	ON
2.05V	ON	ON	ON	ON	ON
2.0V	OFF	OFF	OFF	OFF	OFF
2.1V	ON	OFF	OFF	OFF	OFF
2.2V	OFF	ON	OFF	OFF	OFF
2.3V	ON	ON	OFF	OFF	OFF
2.4V	OFF	OFF	ON	OFF	OFF
2.5V	ON	OFF	ON	OFF	OFF
2.6V	OFF	ON	ON	OFF	OFF
2.7V	ON	ON	ON	OFF	OFF
2.8V	OFF	OFF	OFF	ON	OFF
2.9V	ON	OFF	OFF	ON	OFF
3.0V	OFF	ON	OFF	ON	OFF
3.1V	ON	ON	OFF	ON	OFF
3.2V	OFF	OFF	ON	ON	OFF
3.3V	ON	OFF	ON	ON	OFF
3.4V	OFF	ON	ON	ON	OFF
3.5V	ON	ON	ON	ON	OFF

Hardware Installation

JP12	I/O Voltage (Vio)
1-2	3.3 (default)
3-4	3.45V

JP12 is reserved for testing purposes only. This jumper enables you to set the voltage of the onboard chipset and PBSRAM (Vio). For dual-voltage CPU, JP12 also functions as CPU I/O voltage (Vcpuio) controller.

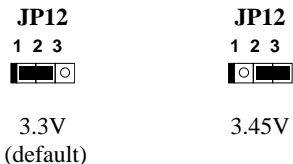
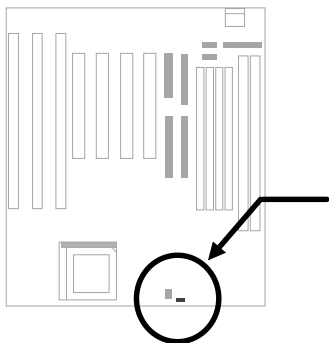

2.2.2 Selecting the CPU Frequency

Intel Pentium, Cyrix 6x86, AMD K5/K6 and IDT C6 CPU are designed to have different Internal (Core) and External (Bus) frequency.

Core frequency = Ratio * External bus clock

S1	S2	S3	CPU Frequency Ratio
OFF	OFF	OFF	1.5x (3.5x)
ON	OFF	OFF	2x
ON	ON	OFF	2.5x (1.75x)
OFF	ON	OFF	3x
ON	OFF	ON	4x
ON	ON	ON	4.5x
OFF	ON	ON	5x

The ratio of Core/Bus frequency is selected by the switch 1-3 of **SW1**.



Note: Intel PP/MT MMX 233MHz is using 1.5x jumper setting for 3.5x frequency ratio, and AMD PR166 is using 2.5x setting for 1.75x frequency ratio.

Hardware Installation

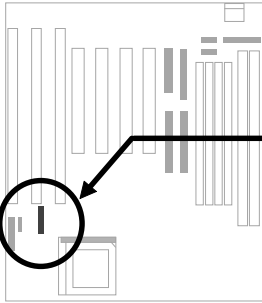

1.5x (3.5x)



4x



2x



4.5x



2.5x (1.75x)



5x



3x



Note: Intel PP/MT 233MHz is using 1.5x jumper setting for 3.5x frequency ratio, and AMD PR166 is using 2.5x setting for 1.75x frequency ratio.

<u>JP4</u>	<u>JP5</u>	<u>JP6</u>	<u>CPU External Clock</u>
1-2	2-3	1-2	60MHz
2-3	1-2	1-2	66MHz
1-2	2-3	2-3	75MHz
2-3	1-2	2-3	83.3MHz

JP4, JP5 and JP6 are the selections of CPU external clock (bus clock), which is actually the clock from clock generator.

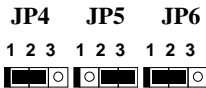
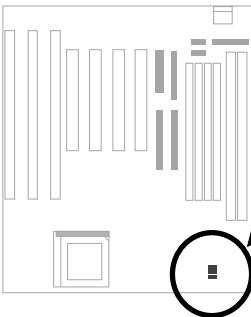

60MHz

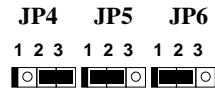

66MHz

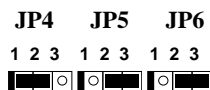

75MHz

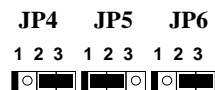

83.3mhz

Hardware Installation



Warning: INTEL TX chipset supports only 60/66MHz external CPU bus clock, the 75/83.3MHz settings are for internal test only, **set to 75/83.3MHz exceeds the specification of TX chipset, which may cause serious system damage.**



Caution: Following table are possible settings of current CPU available on the market. The correct setting may vary because of new CPU product, refer to your CPU specification for more details.



Warning: Cyrix 6x86 P200+ uses 75MHz external clock, the jumper setting shown on the table below is for user's convenient. It may cause serious system damage to use 75MHz clock.

INTEL Pentium	CPU Core Frequency	Ratio	External Bus Clock	S1	S2	S3	JP4 & JP5 & JP6
P54C 90	90MHz =	1.5x	60MHz	OFF	OFF	OFF	1-2 & 2-3 & 1-2
P54C 100	100MHz =	1.5x	66MHz	OFF	OFF	OFF	2-3 & 1-2 & 1-2
P54C 120	120MHz =	2x	60MHz	ON	OFF	OFF	1-2 & 2-3 & 1-2
P54C 133	133MHz =	2x	66MHz	ON	OFF	OFF	2-3 & 1-2 & 1-2
P54C 150	150MHz =	2.5x	60MHz	ON	ON	OFF	1-2 & 2-3 & 1-2
P54C 166	166MHz =	2.5x	66MHz	ON	ON	OFF	2-3 & 1-2 & 1-2
P54C 200	200MHz =	3x	66MHz	OFF	ON	OFF	2-3 & 1-2 & 1-2

INTEL Pentium MMX	CPU Core Frequency	Ratio	External Bus Clock	S1	S2	S3	JP4 & JP5 & JP6
PP/MT 150	150MHz =	2.5x	60MHz	ON	ON	OFF	1-2 & 2-3 & 1-2
PP/MT 166	166MHz =	2.5x	66MHz	ON	ON	OFF	2-3 & 1-2 & 1-2
PP/MT 200	200MHz =	3x	66MHz	OFF	ON	OFF	2-3 & 1-2 & 1-2
PP/MT 233	233MHz =	3.5x	66MHz	OFF	OFF	OFF	2-3 & 1-2 & 1-2

AMD K5	CPU Core Frequency	Ratio	External Bus Clock	S1	S2	S3	JP4 & JP5 & JP6
PR90	90MHz =	1.5x	60MHz	OFF	OFF	OFF	1-2 & 2-3 & 1-2
PR100	100MHz =	1.5x	66MHz	OFF	OFF	OFF	2-3 & 1-2 & 1-2
PR120	90MHz =	1.5x	60MHz	OFF	OFF	OFF	1-2 & 2-3 & 1-2
PR133	100MHz =	1.5x	66MHz	OFF	OFF	OFF	2-3 & 1-2 & 1-2
PR166	116MHz =	1.75x	66MHz	ON	ON	OFF	2-3 & 1-2 & 1-2

Hardware Installation

AMD K6	CPU Core Frequency	Ratio	External Bus Clock	S1	S2	S3	JP4 & JP5 & JP6
PR2-166	166MHz =	2.5x	66MHz	ON	ON	OFF	2-3 & 1-2 & 1-2
PR2-200	200MHz =	3x	66MHz	OFF	ON	OFF	2-3 & 1-2 & 1-2
PR2-233	233MHz =	3.5x	66MHz	OFF	OFF	OFF	2-3 & 1-2 & 1-2
PR2-266	266MHz=	4x	66MHz	ON	OFF	ON	2-3 & 1-2 & 1-2
PR2-300	300MHz=	4.5x	66MHz	ON	ON	ON	2-3 & 1-2 & 1-2

Cyrix 6x86 & 6x86L	CPU Core Frequency	Ratio	External Bus Clock	S1	S2	S3	JP4 & JP5 & JP6
P150+	120MHz =	2x	60MHz	ON	OFF	OFF	1-2 & 2-3 & 1-2
P166+	133MHz =	2x	66MHz	ON	OFF	OFF	2-3 & 1-2 & 1-2
P200+	150MHz =	2x	75MHz	ON	OFF	OFF	1-2 & 2-3 & 2-3

Cyrix M2	CPU Core Frequency	Ratio	External Bus Clock	S1	S2	S3	JP4 & JP5 & JP6
MX-PR166	150MHz =	2.5x	60MHz	ON	ON	OFF	1-2 & 2-3 & 1-2
MX-PR200	166MHz =	2.5x	66MHz	ON	ON	OFF	2-3 & 1-2 & 1-2
	150MHz=	2x	75MHz	ON	OFF	OFF	1-2 & 2-3 & 2-3
MX-PR233	200MHz =	3x	66MHz	OFF	ON	OFF	2-3 & 1-2 & 1-2
	166MHz=	2x	83.3MHz	ON	OFF	OFF	2-3 & 1-2 & 2-3
MX-PR266	233MHz =	3.5x	66MHz	OFF	OFF	OFF	2-3 & 1-2 & 1-2

IDT C6	CPU Core Frequency	Ratio	External Bus Clock	S1	S2	S3	JP4 & JP5 & JP6
C6-150	150MHz =	2x	75MHz	ON	OFF	OFF	1-2 & 2-3 & 2-3
C6-180	180MHz =	3x	60MHz	OFF	ON	OFF	1-2 & 2-3 & 1-2
C6-200	200MHz =	3x	66MHz	OFF	ON	OFF	2-3 & 1-2 & 1-2



Note: Cyrix 6x86 and AMD K5 CPU use P-rating for the reference of CPU benchmark compared with INTEL P54C, their internal core frequency is not exactly equal to P-rating marked on the CPU. For example, Cyrix P166+ is 133MHz but performance is almost equal to P54C 166MHz and AMD PR133 is 100MHz but performance is almost equal to INTEL P54C 133MHz.

Note: INTEL TX chipset does not support CPU with 50/55MHz external bus clock, so that P54C 75MHz, Cyrix P120+, P133+ and AMD PR75 are not supported by this mainboard.

Hardware Installation

2.2.3 Clearing the CMOS

JP14	Clear CMOS
1-2	Normal operation (default)
2-3	Clear CMOS

You need to clear the CMOS if you forget your system password. To clear the CMOS, follow the procedures listed below:

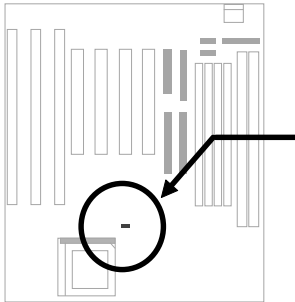

JP14



Normal Operation
(default)

JP14



Clear CMOS

The procedure to clear CMOS:

1. Turn off the system power.
2. Locate **JP14** and short pins 2-3 for a few seconds.
3. Return **JP14** to its normal setting by shorting pins 1-2.
4. Turn on the system power.
5. Press **[DEL]** during bootup to enter the BIOS Setup Utility and specify a new password, if needed.

2.3 Connectors

2.3.1 Power Cable

A standard baby AT (PS/2) power supply has two cables with six wires on each. Plug in these cables to the onboard power connector in such a way that all the black wires are in the center. The power connector is marked as **PWR1** on the system board.



Caution: Make sure that the power supply is off before connecting or disconnecting the power cable.

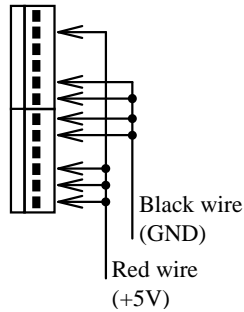
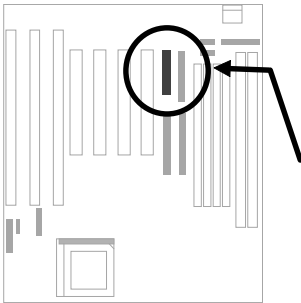

PWR1

Hardware Installation

2.3.2 CPU Fan

Plug in the fan cable to the two-pin fan connector onboard. The fan connector is marked **CPUFAN** on the system board. Attach the heatsink and fan to the CPU. Check its orientation, make sure the air flow go through the heatsink.

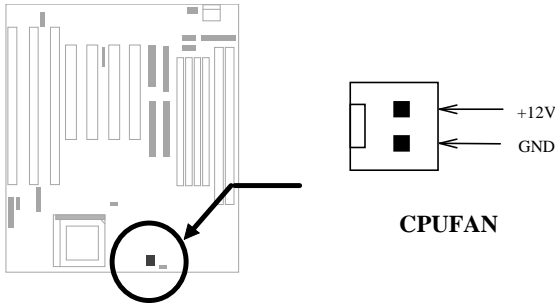

2.3.3 PS/2 Mouse

To connect a PS/2 mouse, insert the PS/2 mouse bracket connector to **PS2 MS** on the system board. Then plug in the PS/2 mouse cable to the mouse port on the bracket.

<u>Pin</u>	<u>Description</u>
1	MS DATA
2	NC
3	GND
4	+5V
5	MS CLK
6	NC

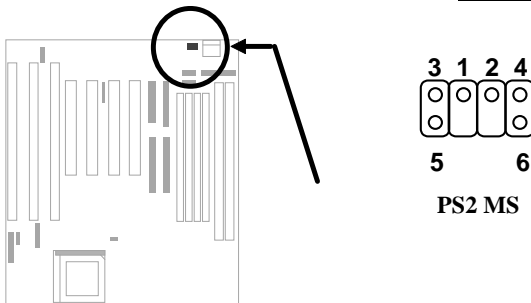

2.3.4 Serial Devices (COM1/COM2)

To support serial devices, insert the serial device connector into the serial port on the bracket. Plug in the 10-pin flat cable to the appropriate onboard connectors. The serial port 1 connector is marked as **COM1** and the serial port 2 connector is marked as **COM2** on the system board.

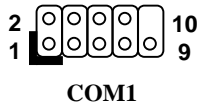
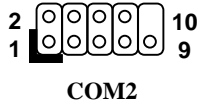
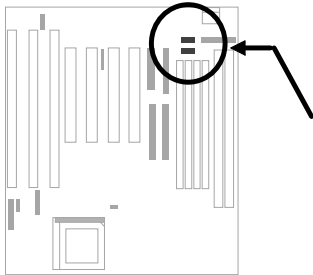

2.3.5 USB Device (optional)

You need a USB bracket to have your system to support additional USB device(s). To attach a USB bracket, simply insert the bracket cable to the onboard USB connector marked as **USB**.

<u>Pin</u>	<u>Description</u>	<u>Pin</u>	<u>Description</u>
1	V0	2	V1
3	D0-	4	D1-
5	D0+	6	D1+
7	GND	8	GND
9	NC	10	NC

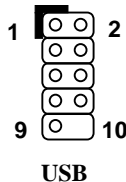
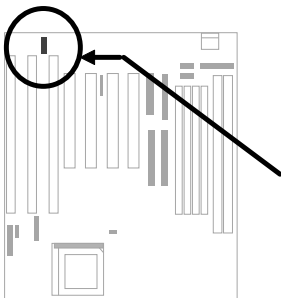

Hardware Installation

2.3.6 Floppy Drive

Connect the 34-pin floppy drive cable to the floppy drive connector marked as **FDC** on the system board.

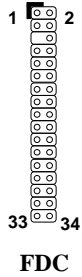
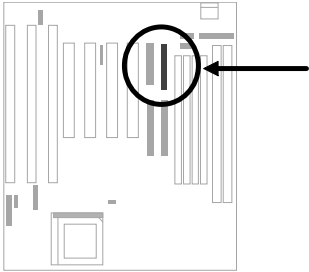

2.3.7 Printer

Plug in the 26-pin printer flat cable to the onboard parallel connector marked as **PRINTER** on the board.

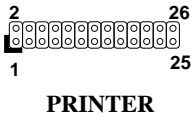
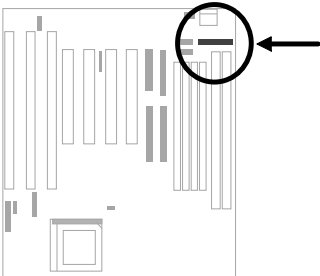

2.3.8 IDE Hard Disk and CD ROM

This mainboard supports two 40 pin IDE connectors marked as **IDE1** and **IDE2**. IDE1 is also known as primary channel and IDE2 as secondary channel, each channel supports two IDE devices that makes total of four devices.

In order to work together, the two devices on each channel must be set differently to master and slave mode, either one can be hard disk or CDROM. The setting as master or slave mode depends on the jumper on your IDE device, please refer to your hard disk and CDROM manual accordingly.

Connect your first IDE hard disk to master mode of the primary channel. If you have second IDE device to install in your system, connect it as slave mode on the same channel, and the third and fourth device can be connected on secondary channel as master and slave mode respectively.

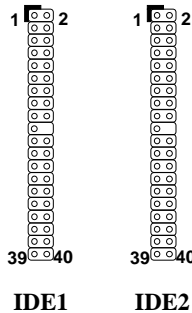
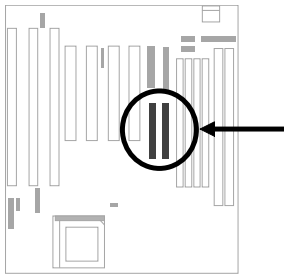

Caution: The specification of IDE cable is maximum 46cm (18 inches), make sure your cable does not exceed this length.

Caution: For better signal quality, it is recommended to set far end side device to master mode and follow the suggested sequence to install your new device . Please refer to following figure.

Hardware Installation

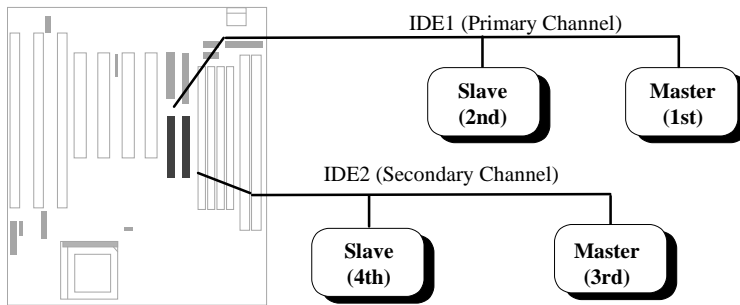

2.3.9 Hard Disk LED

The HDD LED connector is marked as **HDD LED** on the board. This connector is designed for different type of housing, actually only two pins are necessary for the LED. If your housing has four pin connector, simply plug it in. If you have only two pin connector, please connect to pin 1-2 or pin 3-4 according to the polarity.

<u>Pin</u>	<u>Description</u>
1	HDD LED
2	GND
3	GND
4	HDD LED

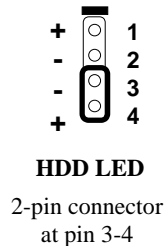
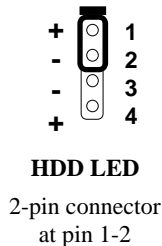
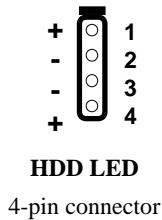
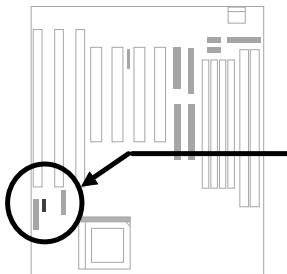

Hardware Installation

2.3.10 Panel Connector

The Panel (multifunction) connector is a 20-pin connector marked as **PANEL** on the board. Attach the power LED, keylock, speaker, reset switch, suspend switch, and green mode LED connectors to the corresponding pins as shown in the figure.

Some housings have a five-pin connector for the keylock and power LED. Since power LED and keylock are aligned together, you can still use this kind of connector.

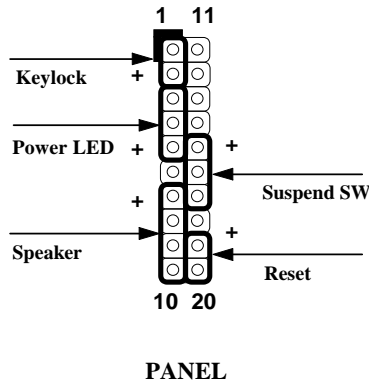
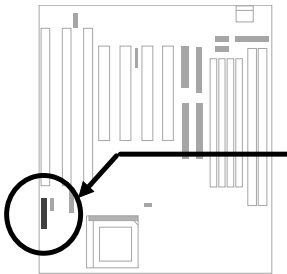
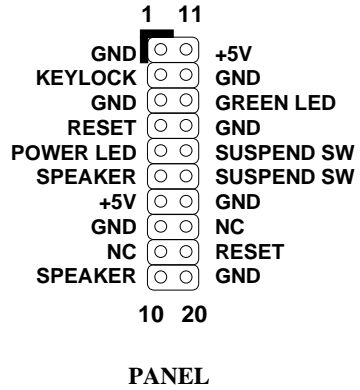

Other housings may have a 12-pin connector. If your housing has this type of connector, connect it to PANEL as shown in the figure. Make sure that the red wire of the connector is connected to +5V.

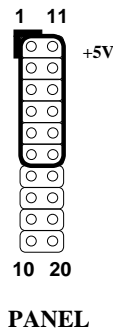

Hardware Installation



Note: If your housing comes with a Turbo switch, you may use this connector for Suspend switch function.

Note: Pressing the Suspend switch allows you to manually force the system to suspend mode. However, this is possible only if the Power Management function in the BIOS Setup menu is enabled.



Warning: If you use toggle mode Turbo switch as Suspend switch, be sure to push it twice to simulate momentary mode. Otherwise the system may hang or fail to reboot.

2.3.11 Keyboard

The onboard keyboard connector is a five-pin AT-compatible connector marked as **KB1**. The view angle of drawing shown here is from back panel of the housing.



Note: The mini DIN PS/2 keyboard connector is optional.

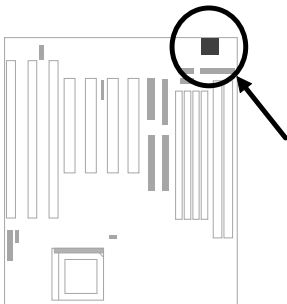

2.3.12 IrDA Connector

Serial port 2 can be configured to support wireless infrared module, with this module and application software such as Laplink, user can transfer files to or from laptops, notebooks, PDA and printers. This mainboard supports IrDA (115Kbps, 1 meter) as well as ASK-IR (19.2Kbps).

Install infrared module onto **IrDA** connector and enable infrared function from BIOS setup, make sure to have correct orientation when you plug onto IrDA connector.

<u>Pin</u>	<u>Description</u>
1	+5V
2	NC
3	IRRX
4	GND
5	IRTX
6	NC



Note: Onboard serial port 2 (COM2) will not be available after IrDA connector is enabled.

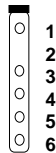
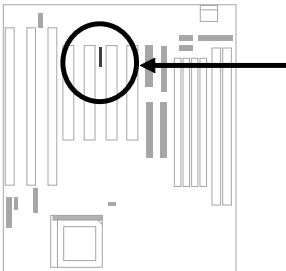

IrDA

Hardware Installation

2.3.13 SB-LINK

SB-LINK is used to connect Creative-compatible PCI sound card. If you have a Creative-compatible PCI sound card installed, it is necessary to link the card to the connector for compatibility issue under DOS environment.

Pin	Description
1	GNT#
2	GND
3	NC
4	REQ#
5	GND
6	SIRQ#

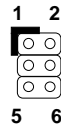
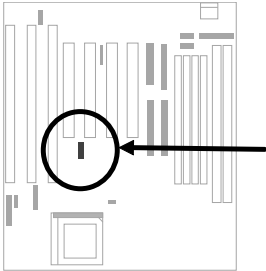

SB-LINK

2.4 Installing the System Memory

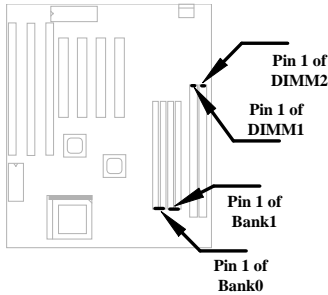

This mainboard has four 72 pin SIMM sockets (Single-in-line Memory Module) and two 168 pin DIMM socket (Dual-in-line Memory Module) that allow you to install system memory from minimum 8MB up to maximum 256MB.

The SIMM supported by this mainboard can be identified by 4 kinds of factors:

- I. **Size:** single side, 1Mx32 (4MB), 4Mx32 (16MB), 16Mx32 (64MB), and double side, 1Mx32x2 (8MB), 4Mx32x2 (32MB), 16Mx32x2 (128MB).
- II. **Speed:** 60ns or 70ns access time
- III. **Type:** FPM (Fast page mode) or EDO (Extended data output)
- IV. **Parity:** without parity (32 bit wide) or with parity (36 bit wide).

The DIMM supported by this motherboard are always 64-bit wide SDRAM, which can be identified by following factors:

- I. **Size:** single side, 1Mx64 (8MB), 2Mx64 (16MB), 4Mx64 (32MB), 8Mx64 (64MB), 16Mx64 (128MB), and double side, 1Mx64x2 (16MB), 2Mx64x2 (32MB), 4Mx64x2 (64MB), 8Mx64x2 (128MB).



Tip: Here is a trick to check if your DIMM is single-side or double-side -- if there are traces connected to golden finger pin 114 and pin 129 of the DIMM, the DIMM is probably double-side; otherwise, it is single-side. Following figure is for your reference.

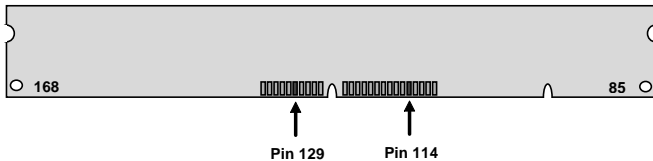

Hardware Installation

- II. **Speed:** normally marked as -12, which means the clock cycle time is 12ns and maximum clock of this SDRAM is 83MHz. Sometimes you can also find the SDRAM marked as -67, which means maximum clock is 67MHz.
- III. **Buffered and non-buffered:** This motherboard supports non-buffered DIMMs. You can identify non-buffered DIMMs and buffered DIMMs according to the position of the notch, following figure is for your reference:

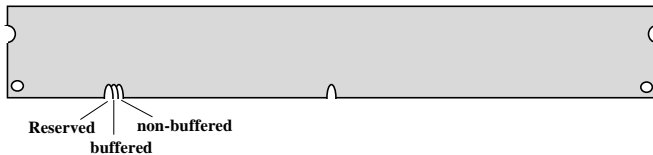

Because the positions are different, only non-buffered DIMMs can be inserted into the DIMM sockets on this motherboard. Although most of DIMMs on current market are non-buffered, we still recommend you to ask your dealer for the correct type.

- IV. **2-clock and 4-clock signals:** Although both of 2-clock and 4-clock signals are supported by this motherboard, we strongly recommend you to choose 4-clock SDRAM in consideration of reliability.



Tip: To identify 2-clock and 4-clock SDRAM, you may check if there are traces connected to golden finger pin 79 and pin 163 of the SDRAM. If there are traces, the SDRAM is probably 4-clock; Otherwise, it is 2-clock.

- V. **Parity:** This motherboard supports standard 64 bit wide (without parity) SDRAM.

Because Pentium CPU has 64 bit bus width, the SIMM sockets are arranged in two banks of two sockets each, they are Bank0 and Bank1. Both SIMMs in each bank must be in the same size and type. It is allowed to have different speed and type in different bank, for example, 70ns FPM in one bank and 60ns EDO in another bank, in such case, each bank is independently optimized for maximum performance. The memory timing requires at least 70ns fast page mode DRAM chip, but for optimum performance, 60ns EDO DRAM is recommended.



Warning: The default memory timing setting is 60ns to obtain the optimal performance. Because of the specification limitation, 70ns SIMM is recommended to be used only for CPU external clock 60MHz.

Hardware Installation

There is no jumper setting required for the memory size or type. It is automatically detected by the system BIOS. You can use any single side SIMM and DIMM combination list below for BANK0/BANK1 or DIMM socket, and the total memory size is to add them together. **Note that because TX chipset limitation, the maximum is only 256MB.**

SIMM1	SIMM2	Subtotal of Bank0
None	None	0MB
4MB	4MB	8MB
8MB	8MB	16MB
16MB	16MB	32MB
32MB	32MB	64MB
64MB	64MB	128MB
128MB	128MB	256MB

SIMM3	SIMM4	Subtotal of Bank1
None	None	0MB
4MB	4MB	8MB
8MB	8MB	16MB
16MB	16MB	32MB
32MB	32MB	64MB
64MB	64MB	128MB
128MB	128MB	256MB

DIMM1	Size of DIMM1
None	0MB
8MB	8MB
16MB	16MB
32MB	32MB
64MB	64MB
128MB	128MB
256MB	256MB

DIMM2	Size of DIMM2
None	0MB
8MB	8MB
16MB	16MB
32MB	32MB
64MB	64MB
128MB	128MB
256MB	256MB

**Total Memory Size = Subtotal of Bank0 + Subtotal of Bank1
+ Size of DIMM1 + Size of DIMM2**

For double side memory module, there is one limitation. This mainboard supports only 4 RAS# (Row address latch) signals for DRAM control. They can only be occupied by one DRAM module, they can not be shared. **The simple rule is: If double side module at either Bank0 or DIMM1, the other must be empty. If you use at DIMM1, Bank0 must be empty. Bank1 and DIMM2 have the same limitation.**

Hardware Installation

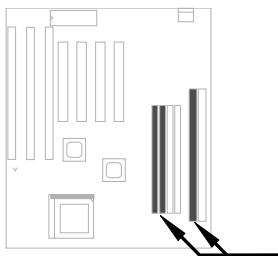

Double side module at either Bank0 or DIMM1, the other must be empty.

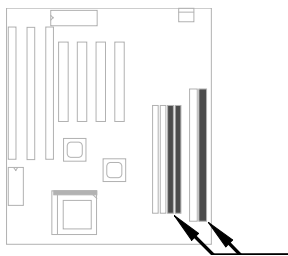

Double side module at either Bank1 or DIMM2, the other must be empty.

Following table explains more about the RAS limitation. You can see that Bank0 1st side and DIMM1 2nd side use the same RAS0#, and Bank0 2nd side and DIMM1 1st side use the same RAS1#. If you are using single side SIMM at Bank0 and single side DIMM at DIMM1, it should be no problem. But only one double side DIMM or double side SIMM can be at Bank0 or DIMM1.

	Bank0 1st side	Bank0 2nd side	Bank1 1st side	Bank1 2nd side	DIMM1 1st side	DIMM1 2nd side	DIMM2 1st side	DIMM2 2nd side
RAS0#	X					X		
RAS1#		X			X			
RAS2#			X					X
RAS3#				X			X	



Caution: Make sure that you install the same SIMM type and size for each bank.

Caution: There are some old DIMMs made by EDO or FPM memory chip, they can only accept 5V power and probably can not fit into the DIMM socket, make sure you have 3.3V true SDRAM DIMM before your insert it.



Tip: If you have DIMM made by 3V EDO, it is possible that TX chipset can support it. But because it is so rare, the only 3V EDO DIMM had been tested by this mainboard is Micron MT4LC2M8E7DJ-6.



Warning: Do not use SIMM and SDRAM DIMM together unless you have 5V tolerance SDRAM (such as Samsung or TI). The FPM/EDO operate at 5V while SDRAM operates at 3.3V. If you combine them together the system will temporary work fine; however after a few months, the SDRAM 3.3V data input will be damaged by 5V FPM/EDO data output line.

Hardware Installation

There is an important parameter affects SDRAM performance, CAS Latency Time. It is similar as CAS Access Time of EDO DRAM and is calculated as number of clock state. The SDRAM that AOpen had tested are listed below. If your SDRAM has unstable problem, go into BIOS "Chipset Features Setup", change CAS Latency Time to 3 clocks.

Manufacturer	Model	Suggested CAS Latency Time	5V Tolerance
Samsung	KM416511220AT-G12	2	Yes
NEC	D4S16162G5-A12-7JF	2	No
Hitachi	HM5216805TT10	2	No
Fujitsu	81117822A-100FN	2	No
TI	TMX626812DGE-12	2	Yes
TI	TMS626812DGE-15	3	Yes
TI	TMS626162DGE-15	3	Yes
TI	TMS626162DGE-M67	3	Yes

The driving capability of new generation chipset is limited because the lack of memory buffer (to improve performance). This makes DRAM chip count an important factor to be taking into consideration when you install SIMM/DIMM. Unfortunately, there is no way that BIOS can identified the correct chip count, you need to calculate the chip count by yourself. The simple rule is: By visual inspection, use only SIMM with chip count less than 24 chips, and use only DIMM which is less than 16 chips.



Warning: Do not install any SIMM that contains more than 24 chips. SIMMs contain more than 24 chips exceed the chipset driving specification. Doing so may result in unstable system behavior.

Warning: Although Intel TX chipset supports x4 SDRAM chip. Due to loading issue, it is not recommended to use this kind of SDRAM.



Tip: The SIMM/DIMM chip count can be calculated by following example:

1. For 32 bit non-parity SIMM using 1M by 4 bit DRAM chip, $32/4=8$ chips.
2. For 36 bit parity SIMM using 1M by 4 bit DRAM chip, $36/4=9$ chips.
3. For 36 bit parity SIMM using 1M by 4 bit and 1M by 1 bit DRAM, the chip count will be 8 data chips($8= 32/4$) plus 4

Hardware Installation

parity chips(4=4/1), total is 12 chips.

4. For 64 bit DIMM using 1M by 16 bit SDRAM, the chip count is $64/16=4$ chips.

Following table list the recommended DRAM combinations of SIMM and DIMM:

SIMM Data chip	SIMM Parity chip	Bit size per side	Single/ Double side	Chip count	SIMM size	Recommended
1M by 4	None	1Mx32	x1	8	4MB	Yes
1M by 4	None	1Mx32	x2	16	8MB	Yes
1M by 4	1M by 1	1Mx36	x1	12	4MB	Yes
1M by 4	1M by 4	1Mx36	x1	9	4MB	Yes
1M by 4	1M by 4	1Mx36	x2	18	8MB	Yes
1M by 16	None	1Mx32	x1	2	4MB	Yes
1M by 16	None	1Mx32	x2	4	8MB	Yes
1M by 16	1M by 4	1Mx36	x1	3	4MB	Yes
1M by 16	1M by 4	1Mx36	x2	6	8MB	Yes
4M by 4	None	4Mx32	x1	8	16MB	Yes
4M by 4	None	4Mx32	x2	16	32MB	Yes
4M by 4	4M by 1	4Mx36	x1	12	16MB	Yes
4M by 4	4M by 1	4Mx36	x2	24	32MB	Yes

SIMM Data chip	SIMM Parity chip	Bit size per side	Single/ Double side	Chip count	SIMM size	Recommended
16M by 4	None	16Mx32	x1	8	64MB	Yes, but not tested.
16M by 4	None	16Mx32	x2	16	128MB	Yes, but not tested.
16M by 4	16M by 4	16Mx36	x1	9	64MB	Yes, but not tested.
16M by 4	16M by 4	16Mx36	x2	18	128MB	Yes, but not tested.

DIMM Data chip	Bit size per side	Single/ Double side	Chip count	DIMM size	Recommended
1M by 16	1Mx64	x1	4	8MB	Yes
1M by 16	1Mx64	x2	8	16MB	Yes
2M by 8	2Mx64	x1	8	16MB	Yes
2M by 8	2Mx64	x2	16	32MB	Yes

Hardware Installation

DIMM Data chip	Bit size per side	Single/ Double side	Chip count	DIMM size	Recommended
2M by 32	2Mx64	x1	2	16MB	Yes, but not tested.
2M by 32	2Mx64	x2	4	32MB	Yes, but not tested.
4M by 16	4Mx64	x1	4	32MB	Yes, but not tested.
4M by 16	4Mx64	x2	8	64MB	Yes, but not tested.
8M by 8	8Mx64	x1	8	64MB	Yes, but not tested.
8M by 8	8Mx64	x2	16	128MB	Yes, but not tested.



Warning: 64MB SIMMs using 16M by 4 bit chip (64M bit technology) are not available in the market and are not formally tested by AOpen quality test department yet. However they are supported by design specification from Intel and they will be tested as soon as they are available. Note that 64MB SIMMs using 16M by 1 bit chip (16M bit technology) have chip count exceed 24 and are strongly not recommended.



Tip: 8 bit = 1 byte, 32 bit = 4 byte. The SIMM size is represented by number of data byte (whether with or without parity), for example, the size of single side SIMM using 1M by 4 bit chip is 1Mx32 bit, that is, 1M x 4 byte= 4MB. For double side SIMM, simply multiply it by 2, that is, 8MB.

Hardware Installation

Following table are possible DRAM combinations that is **NOT** recommended:

SIMM Data chip	SIMM Parity chip	Bit size per side	Single/ Double side	Chip count	SIMM size	Recommended
1M by 1	None	1Mx32	x1	32	4MB	No
1M by 1	1M by 1	1Mx36	x1	36	4MB	No
1M by 4	1M by 1	1Mx36	x2	24	8MB	No
4M by 1	None	4Mx32	x1	32	16MB	No
4M by 1	4M by 1	4Mx36	x1	36	16MB	No
16M by 1	None	16Mx32	x1	32	64MB	No
16M by 1	16M by 1	16Mx36	x1	36	64MB	No

DIMM Data chip	Bit size per side	Single/ Double side	Chip count	DIMM size	Recommended
4M by 4	4Mx64	x1	16	32MB	No
4M by 4	4Mx64	x2	32	64MB	No
16M by 4	16Mx64	x1	16	128MB	No
16M by 4	16Mx64	x2	32	256MB	No

Memory error checking is supported by parity check. To use parity check you need 36 bit SIMM (32 bit data + 4 bit parity), which are automatically detected by BIOS.



Tip: The parity mode uses 1 parity bit for each byte, normally it is even parity mode, that is, each time the memory data is updated, parity bit will be adjusted to have even count "1" for each byte. When next time, if memory is read with odd number of "1", the parity error is occurred and this is called single bit error detection.

Chapter 3

Award BIOS

This chapter tells how to configure the system parameters. You may update your BIOS via AWARD Flash Utility.



Important: *Because the BIOS code is the most often changed part of the mainboard design, the BIOS information contained in this chapter (especially the Chipset Setup parameters) may be a little different compared to the actual BIOS that came with your mainboard.*

AWARD BIOS

3.1 Entering the Award BIOS Setup Menu

The BIOS setup utility is a segment of codes/routines residing in the BIOS Flash ROM. This routine allows you to configure the system parameters and save the configuration into the 128 byte CMOS area, (normally in the RTC chip or directly in the main chipset). To enter the BIOS Setup, press **[DEL]** during POST (Power-On Self Test). The BIOS Setup Main Menu appears as follows.

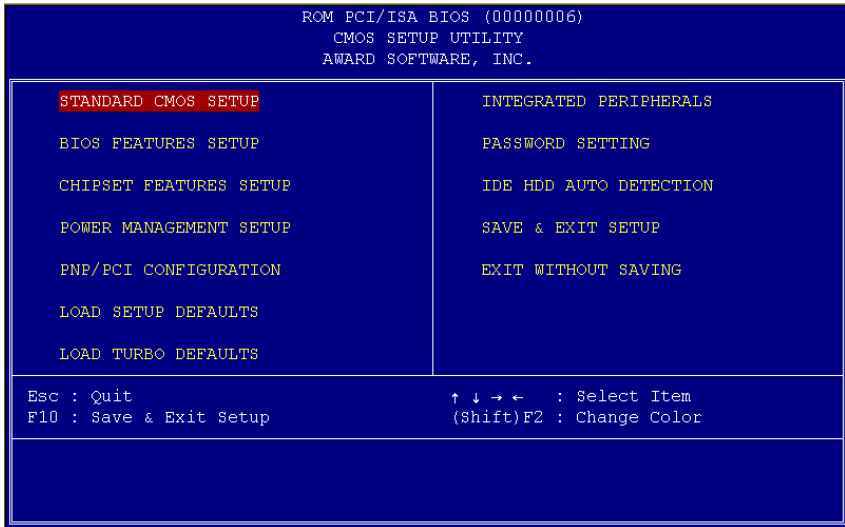

Tip: Choose "Load Setup Defaults" for recommended optimal performance. Choose "Load Turbo Defaults" for best performance with light system loading. Refer to section 3.7.

The section at the bottom of the screen tells how to control the screen. Use the arrow keys to move between items, **[SHIFT]** **[F2]** to color scheme of the display, **[ESC]** to exit, and **[F10]** to save the changes before exit. Another section at the bottom of the screen displays a brief description of the highlighted item.

After selecting an item, press **[ENTER]** to select or enter a submenu.

3.2 Standard CMOS Setup

The "Standard CMOS Setup" sets the basic system parameters such as the date, time, and the hard disk type. Use the arrow keys to highlight an item and **[PGUP]** or **[PGDN]** to select the value for each item.

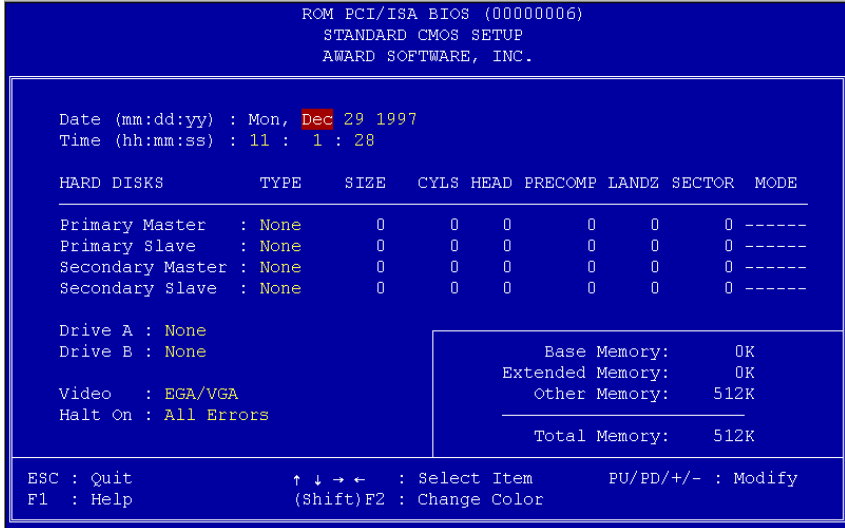

Standard CMOS à Date

To set the date, highlight the Date parameter. Press **[PGUP]** or **[PGDN]** to set the current date. The date format is month, date, and year.

Standard CMOS à Time

To set the time, highlight the Time parameter. Press **[PGUP]** or **[PGDN]** to set the current time in hour, minute, and second format. The time is based on the 24 hour military clock.

AWARD BIOS

Standard CMOS à Primary Master à Type

Standard CMOS à Primary Slave à Type

Standard CMOS à Secondary Master à Type

Standard CMOS à Secondary Slave à Type

Type
Auto
User
None
1
2
...
45

This item lets you select the IDE hard disk parameters that your system supports. These parameters are Size, Number of Cylinder, Number of Head, Start Cylinder for Pre-compensation, Cylinder number of Head Landing Zone and Number of Sector per Track. The default setting is **Auto**, which enables BIOS to automatically detect the parameters of installed HDD at POST (Power-On Self Test). If you prefer to enter HDD parameters manually, select User. Select None if no HDD is connected to the system.

The IDE CDROM is always automatically detected.



***Tip:** For an IDE hard disk, we recommend that you use the "IDE HDD Auto Detection" to enter the drive specifications automatically. See the section "IDE HDD Auto Detection".*

Standard CMOS à Primary Master à Mode

Standard CMOS à Primary Slave à Mode

Standard CMOS à Secondary Master à Mode

Standard CMOS à Secondary Slave à Mode

Mode
Auto
Normal
LBA
Large

The enhanced IDE feature allows the system to use a hard disk with a capacity of more than 528MB. This is made possible through the Logical Block Address (LBA) mode translation. The LBA is now considered as a standard feature of current IDE hard disk on the market because of its capability to support capacity larger than 528MB. Note that if HDD is formatted with LBA On, it will not be able to boot with LBA Off.

Standard CMOS à Drive A

Standard CMOS à Drive B

Drive A

None
360KB 5.25"
1.2MB 5.25"
720KB 3.5"
1.44MB 3.5"
2.88MB 3.5"

These items select floppy drive type. The available settings and types supported by the mainboard are listed on the left.

Standard CMOS à Video

Video

EGA/VGA
CGA40
CGA80
Mono

This item specifies the type of video card in use. The default setting is VGA/EGA. Since current PCs use VGA only, this function is almost useless and may be disregarded in the future.

Standard CMOS à Halt On

Halt On

No Errors
All Errors
All, But Keyboard
All, But Diskette
All, But Disk/Key

This parameter enables you to control the system stops in case of Power-On Self Test (POST) error.

AWARD BIOS

3.3 BIOS Features Setup

This screen appears when you select the option "BIOS Features Setup" from the main menu.

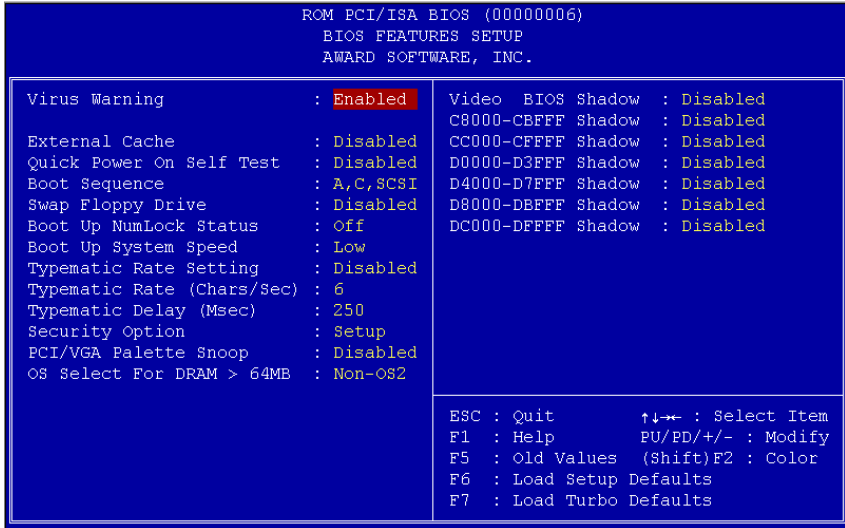

BIOS Features à Virus Warning

<u>Virus Warning</u>
Enabled
Disabled

Set this parameter to Enabled to activate the warning message. This feature protects the boot sector and partition table of your hard disk from virus intrusion.

Any attempt during boot up to write to the boot sector of the hard disk drive stops the system and the following warning message appears on the screen. Run an anti-virus program to locate the problem.

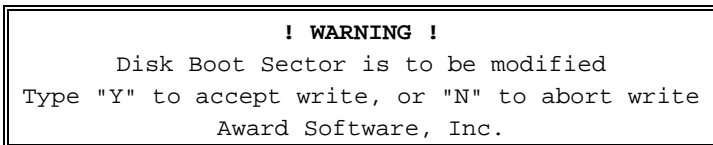

BIOS Features à External Cache

<u>External Cache</u> Enabled Disabled	Enabling this parameter activates the secondary cache (currently, PBSRAM cache). Disabling the parameter slows down the system. Therefore, we recommend that you leave it enabled unless you are troubleshooting a problem.
---	---

BIOS Features à Quick Power On Self Test

<u>Quick Power on Self test</u> Enable Disabled	This parameter speeds up POST by skipping some items that are normally checked.
--	---

BIOS Features à Boot Sequence

<u>Boot Sequence</u> A,C,SCSI C,A,SCSI C,CDROM,A CDROM,C,A D,A,SCSI E,A,SCSI F,A,SCSI SCSI,A,C SCSI,C,A C only LS/ZIP,C	This parameter allows you to specify the system boot up search sequence. The hard disk ID are listed below: C: Primary master D: Primary slave E: Secondary master F: Secondary slave LS: LS120 drive ZIP: IOMEGA ZIP drive
---	---

BIOS Features à Swap Floppy Drive

<u>Swap Floppy Drive</u> Enabled Disabled	This item allows you to swap floppy drives. For example, if you have two floppy drives (A and B), you can assign the first drive as drive B and the second drive as drive A or vice-versa.
--	--

AWARD BIOS

BIOS Features à Boot Up NumLock Status

Boot Up NumLock Status
On
Off

Setting this parameter to On enables the numeric function of the numeric keypad. Set this parameter to Off to disregard the function. Disabling the numeric function allows you to use the numeric keypad for cursor control.

BIOS Features à Boot Up System Speed

Boot Up System Speed
High
Low

Select High or Low system speed after boot.

BIOS Features à Typematic Rate Setting

Typematic Rate Setting
Enabled
Disabled

Set this parameter to Enable/Disable the keyboard repeat function. When enabled, continually holding down a key on the keyboard will generate repeatedly keystrokes.

BIOS Features à Typematic Rate (Chars/Sec)

Typematic Rate
6
8
10
12
15
20
24
30

This item allows you to control the speed of repeated keystrokes. The default is 30 characters/sec.

BIOS Features à Typematic Delay (Msec)

Typematic Delay
250
500
750
1000

This parameter allows you to control the delay time between the first and the second keystroke (where the repeated keystrokes begin). The typematic delay settings are 250, 500, 750, and 1000 msec.

BIOS Features à Security Option

Security Option

Setup
System

The **System** option limits access to both the System boot and BIOS setup. A prompt asking you to enter your password appears on the screen every time you boot the system.

The **Setup** option limits access only to BIOS setup.

To disable the security option, select Password Setting from the main menu, don't type anything and just press <Enter>.

BIOS Features à PCI/VGA Palette Snoop

PCI/VGA Palette Snoop

Enabled
Disabled

Enabling this item informs the PCI VGA card to keep silent (and to prevent conflict) when palette register is updated (i.e., accepts data without responding any communication signals). This is useful only when two display cards use the same palette address and plugged in the PCI bus at the same time (such as MPEQ or Video capture). In such case, PCI VGA is silent while MPEQ/Video capture is set to function normally.

BIOS Features à OS Select for DRAM > 64MB

OS Select for DRAM > 64MB

OS/2
Non-OS/2

Set to OS/2 if your system is utilizing an OS/2 operating system and has a memory size of more than 64 MB.

BIOS Features à Video BIOS Shadow

Video BIOS Shadow

Enabled
Disabled

VGA BIOS Shadowing means to copy video display card BIOS into the DRAM area. This enhances system performance because DRAM access time is faster than ROM.

AWARD BIOS

- BIOS Features à C800-CBFF Shadow**
- BIOS Features à CC00-CFFF Shadow**
- BIOS Features à D000-D3FF Shadow**
- BIOS Features à D400-D7FF Shadow**
- BIOS Features à D800-DBFF Shadow**
- BIOS Features à DC00-DFFF Shadow**

<p><u>C800-CBFF</u></p> <p><u>Shadow</u></p> <p>Enabled</p> <p>Disabled</p>

These six items are for shadowing ROM code on other expansion cards. Before you set these parameters, you need to know the specific addresses of that ROM code. If you do not know this information, enable all the ROM shadow settings.



Note: *The F000 and E000 segments are always shadowed because BIOS code occupies these areas.*

3.4 Chipset Features Setup

The "Chipset Features Setup" includes settings for the chipset dependent features. These features are related to system performance.

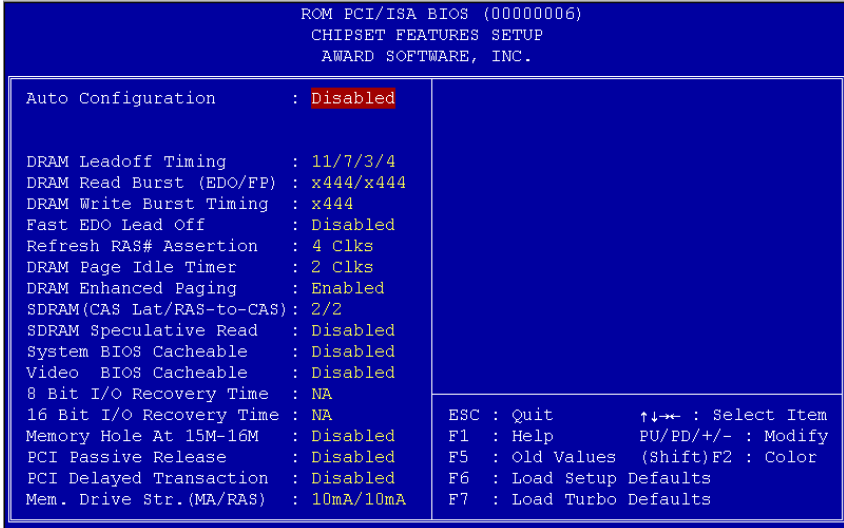

Caution: Make sure you fully understand the items contained in this menu before you try to change anything. You may change the parameter settings to improve system performance. However, it may cause system unstable if the setting are not correct for your system configuration.

AWARD BIOS

Chipset Features à Auto Configuration

Auto Configuration

Enabled
Disabled

When **Enabled**, the DRAM and cache related timing are set to pre-defined value according to CPU type and clock. Select **Disable** if you want to specify your own DRAM timing.

Chipset Features à DRAM Timing

DRAM Timing

60 ns
70 ns

There to sets of DRAM timing parameters can be automatically set by BIOS, 60ns and 70ns.



Warning: *The default memory timing setting is 60ns to get the optimal performance. Because the specification limitation of INTEL TX chipset , 70ns SIMM can only be used with CPU external clock 60MHz. To use 70ns SIMM with 66MHz CPU external clock may result in unstable system behavior.*

Chipset Features à DRAM Leadoff Timing

DRAM Leadoff Timing

11/7/3/4
10/6/3/3
11/7/4/4
10/6/4/3

The Leadoff means the timing of first memory cycle in the burst read or write. Actually, this item controls only page miss read/write leadoff timing and the clocks of RAS precharge and RAS to CAS delay. The four digital represent Read Leadoff/ Write Leadoff/ RAS Precharge/ RAS to CAS delay. For example, default is **10/6/3/3**, which means you have 10-x-x-x DRAM page miss read and 6-x-x-x DRAM write, with 3 clocks RAS precharge and 3 clocks RAS to CAS delay.

Chipset Features à DRAM Read Burst (EDO/FP)

DRAM Read Burst (EDO/FP)

x444/x444
x333/x444
x222/x333

Read Burst means to read four continuous memory cycles on four predefined addresses from the DRAM. The default value is **x222/x333** for 60ns EDO or FPM (Fast Page Mode) DRAM. Which means the 2nd,3rd and 4th memory cycles are 2 CPU clocks for EDO and 3 clocks for FPM. The value of x is the timing of first memory cycle and depends on the "DRAM Leadoff Timing" setting.

Chipset Features à DRAM Write Burst Timing

DRAM Write Burst Timing

x444
x333
x222

Write Burst means to write four continuous memory cycles on four predefined addresses to the DRAM. This item sets the DRAM write timing of the 2nd,3rd and 4th memory cycles. There is no difference of EDO and FPM DRAM on the write burst timing. The value of x depends on the "DRAM Leadoff Timing" setting.

Chipset Features à Fast EDO Lead Off

Fast EDO Lead Off

Enabled
Disabled

This item enables fast EDO read timing, results 1 clock pull-in for read leadoff latency of EDO read cycles. It must be Disabled, if any FPM DRAM is installed.

Chipset Features à Refresh RAS# Assertion

Refresh RAS# Assertion

5 Clks
4 Clks

This item controls the number of clocks RAS is asserted for refresh cycle.

AWARD BIOS

Chipset Features à DRAM Page Idle Timer

DRAM Page Idle

Timer

- 2 Clks
- 4 Clks
- 6 Clks
- 8 Clks

This item determines the amount of time in CPU clocks that DRAM page will be close after CPU becomes idle.

Chipset Features à DRAM Enhance Paging

DRAM Enhance

Paging

- Enabled
- Disabled

When Enabled, TX chipset will keep DRAM page open as long as possible according to enhanced method.

Chipset Features à SDRAM (CAS Lat/RAS-to-CAS)

SDRAM(CAS Lat/RAS-to-CAS)

- 2/2
- 3/3

These are timing of SDRAM CAS Latency and RAS to CAS Delay, calculated by clocks. They are important parameters affects SDRAM performance, default is 2 clocks. If your SDRAM has unstable problem, change 2/2 to 3/3.

Chipset Features à SDRAM Speculative Read

SDRAM Speculative Read

- Enabled
- Disabled

Enable this item reduce one clock of SDRAM read leadoff timing by presenting the SDRAM read request before the controller chip decodes the final memory target. This Item must be **Disabled** if more than one DIMM is installed in the system.

Chipset Features à System BIOS Cacheable

System BIOS Cacheable

- Enabled
- Disabled

Enabling this item allows you to cache the system BIOS to further enhance system performance.

Chipset Features à Video BIOS Cacheable

Video BIOS Cacheable

Enabled
Disabled

Allows the video BIOS to be cached to allow faster video performance.

Chipset Features à 8 Bit I/O Recovery Time

8 Bit I/O Recovery Time

1
2
3
4
5
6
7
8
NA

For some old I/O chips, after the execution of an I/O command, the device requires a certain amount of time (recovery time) before the execution of the next I/O command. Because of new generation CPU and mainboard chipset, the assertion of I/O command is faster, and sometimes shorter than specified I/O recovery time of old I/O devices. This item lets you specify the delay of 8-bit I/O command by count of ISA bus clock. If you find any unstable 8-bit I/O card, you may try to extend the I/O recovery time via this item. The BIOS default value is **4 ISA clock**. If set to NA, the chipset will insert 3.5 system clocks.

Chipset Features à 16 Bit I/O Recovery Time

16 Bit I/O Recovery Time

1
2
3
4
NA

The same as 16-bit I/O recovery time. This item lets you specify the recovery time for the execution of 16-bit I/O commands by count of ISA bus clock. If you find any of the installed 16-bit I/O cards unstable, try extending the I/O recovery time via this item. The BIOS default value is **1 ISA clocks**. If set to NA, the chipset will automatically insert 3.5 system clocks.

AWARD BIOS

Chipset Features à Memory Hole At 15M-16M

**Memory Hole At
15M-16M**

Enabled
Disabled

This option lets you reserve system memory area for special ISA cards. The chipset accesses code/data of these areas from the ISA bus directly. Normally, these areas are reserved for memory mapped I/O card.

Chipset Features à PCI Passive Release

PCI Passive Release

Enabled
Disabled

This item lets you control the Passive Release function of the PIIX4 chipset (Intel PCI to ISA bridge). This function is used to meet latency of ISA bus master. Try to enable or disable it, if you have ISA card compatibility problem.

Chipset Features à PCI Delayed Transaction

**PCI Delayed
Transaction**

Enabled
Disabled

This item lets you control the Delayed Transaction function of the PIIX4 chipset (Intel PCI to ISA bridge). This function is used to meet latency of PCI cycles to or from ISA bus. Try to enable or disable it, if you have ISA card compatibility problem.

Chipset Features à Mem. Drive Str. (MA/RAS)

**Mem. Drive Str.
(MA/RAS)**

10mA/10mA
10mA/16mA
16mA/10mA
16mA/16mA

This option controls the driving strength of memory address and control signals. It is recommended to use less driving current for light memory loading, to prevent undershoot or overshoot.

3.5 Power Management Setup

The Power Management Setup screen enables you to control the mainboard's green features. See the following screen.

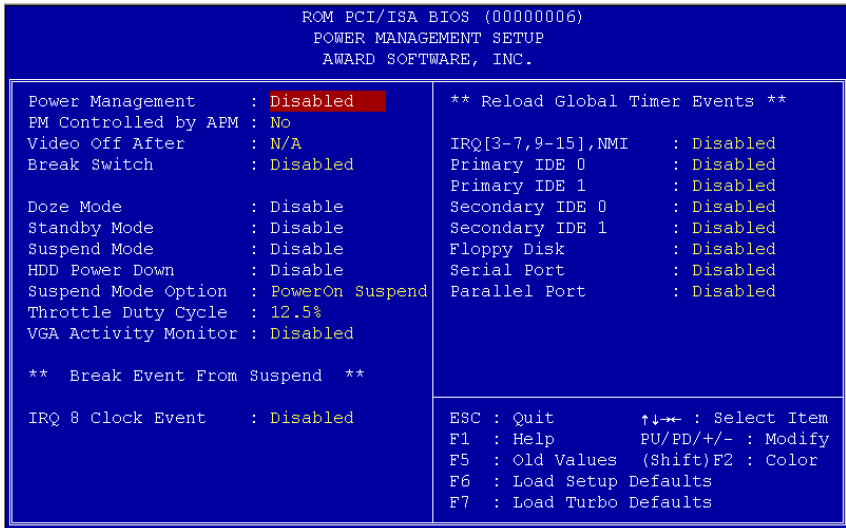

Power Management à Power Management

<u>Power Management</u>
Max Saving
Mix Saving
User Defined
Disabled

This function allows you to set the default parameters of power-saving modes. Set to **Disable** to turn off power management function. Set to User Defined to choose your own parameters.

Mode	Doze	Standby	Suspend	HDD Power Down
Min Saving	1 hour	1 hour	1 hour	15 min
Max Saving	1 min	1 min	1 min	1 min

AWARD BIOS

Power Management à PM Controlled by APM

PM Controlled by

APM

Yes

No

If "Max Saving" is selected, you can turn on this item, transfer power management control to APM (Advanced Power Management) and enhance power saving function. For example, stop CPU internal clock.

Power Management à Video Off After

Video Off After

N/A

Doze

Standby

Suspend

To turn off video monitor at which power down mode.

Power Management à Break Switch

Break Switch

Enabled

Disabled

Setting this item to Enabled allows you to use the Turbo switch as Suspend switch. Pressing the Turbo switch changes nothings for a Pentium system, so we usually use this switch to act as a Suspend switch. The default value of this item is Disabled.



Warning: If you use toggle mode Turbo switch as Suspend switch, be sure to push it twice to simulate momentary mode. Otherwise the system may hang or fail to reboot.

Power Management à Doze Mode

Doze Mode

Disabled

1 Min

2 Min

4 Min

8 Min

12 Min

20 Min

30 Min

40 Min

1 Hour

This item lets you set the period of time after which the system enters into Doze mode. In this mode, the CPU clock slows down. The ratio is specified in the "Throttle Duty Cycle". Any activity detected returns the system to full power. The system activity (or event) is detected by monitoring the IRQ signals.

Power Management à Standby Mode

Standby Mode

Disabled

1 Min

2 Min

4 Min

8 Min

12 Min

20 Min

30 Min

40 Min

1 Hour

This item lets you set the period of time after which the system enters into Standby mode. In this mode, CPU clock slows down, hard disk will be shut off and the monitor power-saving feature activates. Any activity detected returns the system to full power. The system activity (or event) is detected by monitoring the IRQ signals.

Power Management à Suspend Mode

Suspend Mode

Disabled

1 Min

2 Min

4 Min

8 Min

12 Min

20 Min

30 Min

40 Min

1 Hour

This item lets you set the period of time after which the system enters into Suspend mode. The Suspend mode can be Power On Suspend or Suspend to Hard Drive, selected by "Suspend Mode Option".

Power Management à HDD Power Down

HDD Power Down

Disabled

1 Min

.....

15 Min

This option lets you specify the IDE HDD idle time before the device enters the power down state. This item is independent from the power states previously described in this section (Standby and Suspend).

AWARD BIOS

Power Management à Suspend Mode Option

Suspend Mode Option

Power On Suspend
Suspend to Hard Drive

You can select suspend mode by this item. **Power On Suspend** is the traditional Green PC suspend mode, the CPU clock is stop, all other devices are shut off. But power must be kept On to detect activities from modem, keyboard/mouse and returns the system to full power. The system activities is detected by monitoring the IRQ signals. **Suspend to Hard Drive** saves system status, memory and screen image into hard disk, then the power can be totally Off. Next time, when power is turned On, the system goes back to your original work within just few seconds. You need AOZVHDD to reserve disk space. Refer to section 3.16 "Suspend to Hard Drive" for more information".

Power Management à Throttle Duty Cycle

Throttle Duty Cycle

12.5 %
25.0 %
37.5 %
50.0 %
62.5 %
75.0 %
87.5 %

Clock Throttling means at the Doze/Standby state, the CPU clock count in a given time (not the frequency) is reduced to the ratio specified in this parameter. Actually, the period per CPU clock is not changed. For example, a 66MHz CPU clock remains the same 30ns clock period when system goes into Doze/Suspend. The chipset generates the STPCLK (stop clock) signal periodically to prevent CPU for accepting clock from clock generator. For full power on, the CPU can receive 66M count in one second. If the Slow Clock Ratio is set to 50%, the CPU will only receive 33M clock count in one second. This will effectively reduce CPU speed as well as CPU power.

Power Management à VGA Activity Monitor

VGA Activity Monitor

Enabled
Disabled

To enable or disable the detection of VGA activity for power down state transition.

Power Management à IRQ 8 Clock Event

IRQ 8 Clock Event

Enabled
Disabled

To enable or disable the detection of IRQ8 (RTC) event for power down state transition. OS2 has periodically IRQ8 (RTC) interruptions, If IRQ8 is not set to **Disabled**, OS/2 may fail to go into Doze/Standby/Suspend mode.

Power Management à IRQ [3-7,9-15], NMI

IRQ [3-7,9-15], NMI

Enabled
Disabled

To enable or disable the detection of IRQ3-7, IRQ9-15 or NMI interrupt events for power down state transition.

Power Management à Primary IDE 0

Power Management à Primary IDE 1

Power Management à Secondary IDE 0

Power Management à Secondary IDE 1

Power Management à Floppy Disk

Power Management à Serial Port

Power Management à Parallel Port

Primary IDE 0

Enabled
Disabled

These items enable or disable the detection of IDE, floppy, serial and parallel port activities for power down state transition. Actually it detects the read/write to/from I/O or address port.

AWARD BIOS

3.6 PNP/PCI Configuration Setup

The PNP/PCI Configuration Setup allows you to configure the ISA and PCI devices installed in your system. The following screen appears if you select the option "PNP/PCI Configuration Setup" from the main menu.

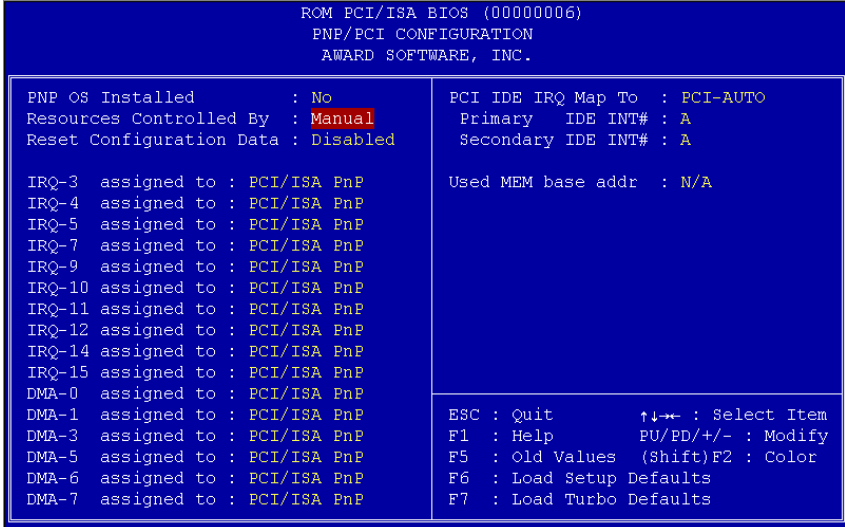

PNP/PCI Configuration à PnP OS Installed

<u>PnP OS Installed</u>
Yes
No

Normally, the PnP resources are allocated by BIOS during POST (Power-On Self Test). If you are using a PnP operating system (such as Windows 95), set this item to Yes to inform BIOS to configure only the resources needed for booting (VGA/IDE or SCSI). The rest of system resources will be allocated by PnP operating system.

PNP/PCI Configuration à Resources Controlled By

<p><u>Resources Controlled by</u> Auto Manual</p>
--

Setting this option to Manual allows you to individually assign the IRQs and DMAs to the ISA and PCI devices. Set this to **Auto** to enable the auto-configuration function.

PNP/PCI Configuration à Reset Configuration Data

<p><u>Reset Configuration Data</u> Enabled Disabled</p>
--

In case conflict occurs after you assign the IRQs or after you configure your system, you can enable this function, allow your system to automatically reset your configuration and reassign the IRQs.

PNP/PCI Configuration à IRQ3 (COM2)

PNP/PCI Configuration à IRQ4 (COM1)

PNP/PCI Configuration à IRQ5 (Network/Sound or Others)

PNP/PCI Configuration à IRQ7 (Printer or Others)

PNP/PCI Configuration à IRQ9 (Video or Others)

PNP/PCI Configuration à IRQ10 (SCSI or Others)

PNP/PCI Configuration à IRQ11 (SCSI or Others)

PNP/PCI Configuration à IRQ12 (PS/2 Mouse)

PNP/PCI Configuration à IRQ14 (IDE1)

PNP/PCI Configuration à IRQ15 (IDE2)

<p><u>IRQ 3</u> Legacy ISA PCI/ISA PnP</p>

If your ISA card is not PnP compatible and requires a special IRQ to support its function, set the selected IRQ to **Legacy ISA**. This setting informs the PnP BIOS to reserve the selected IRQ for the installed legacy ISA card. The default is **PCI/ISA PnP**. Take note that PCI cards are always PnP compatible (except old PCI IDE card).

AWARD BIOS

- PNP/PCI Configuration à DMA 0
- PNP/PCI Configuration à DMA 1
- PNP/PCI Configuration à DMA 3
- PNP/PCI Configuration à DMA 5
- PNP/PCI Configuration à DMA 6
- PNP/PCI Configuration à DMA 7

DMA 0
Legacy ISA
PCI/ISA PnP

If your ISA card is not PnP compatible and requires a special DMA channel to support its function, set the selected DMA channel to **Legacy ISA**. This setting informs the PnP BIOS to reserve the selected DMA channel for the installed legacy ISA card. The default is **PCI/ISA PnP**. Take note that PCI card does not require DMA channel.

PNP/PCI Configuration à PCI IDE IRQ Map To

PCI IDE IRQ Map To
ISA
PCI-Slot1
PCI-Slot2
PCI-Slot3
PCI-Slot4
PCI-Auto

Some old PCI IDE add-on cards are not fully PnP compatible. These cards require you to specify the slot in use to enable BIOS to properly configure the PnP resources. This function allows you to select the PCI slot for any PCI IDE add-on card present in your system. Set this item to **Auto** to allow BIOS to automatically configure the installed PCI IDE card(s).

- PNP/PCI Configuration à Primary IDE INT#
- PNP/PCI Configuration à Secondary IDE INT#

Primary IDE INT#
A
B
C
D

These two items, in conjunction with item "PCI IDE IRQ Map To", specify the IRQ routing of the primary or secondary channel of the PCI IDE add-on card (not the onboard IDE). Each PCI slot has four PCI interrupts aligned as listed in the table below. You must specify the slot in the "PCI IDE IRQ Map To", and set the PCI interrupt (INTx) here according to the interrupt connection on the card.

PCI Slot	Location 1 (pin A6)	Location 2 (pin B7)	Location 3 (pin A7)	Location 4 (pin B8)
----------	------------------------	------------------------	------------------------	------------------------

Slot 1	INTA	INTB	INTC	INTD
Slot 2	INTB	INTC	INTD	INTA
Slot 3	INTC	INTD	INTA	INTB
Slot 4	INTD	INTA	INTB	INTC
Slot 5 (if any)	INTD	INTA	INTB	INTC

PNP/PCI Configuration à Used MEM Base Addr

<u>Used MEM base addr</u>
N/A
C800
CC00
D000
D400
D800
DC00

This item, in conjunction with the "Used MEM Length", lets you set a memory space for non-PnP compatible ISA card. This item specifies the memory base (start address) of the reserved memory space. The memory size is specified in the "Used MEM Length" .

PNP/PCI Configuration à Used MEM Length

<u>Used MEM Length</u>
8K
16K
32K
64K

If your ISA card is not PnP compatible and requires special memory space to support its function, specify the memory size in this parameter to inform the PnP BIOS to reserve the specified memory space for installed legacy ISA card.

3.7 Load Setup Defaults

The "Load Setup Defaults" option loads optimized settings for optimum system performance. Optimal settings are relatively safer than the Turbo settings. We recommend you to use the Optimal settings if your system has large memory size and fully loaded with add-on card (for example, a file server using double-sided 8MB SIMM x4 and SCSI plus Network card occupying the PCI and ISA slots).

Optimal is not the slowest setting for this mainboard. If you need to verify a unstable problem, you may manually set the parameter in the "BIOS Features Setup" and "Chipset Features Setup" to get slowest and safer setting.

3.8 Load Turbo Defaults

The "Load Turbo Defaults" option gives better performance than Optimal values. However, Turbo values may not be the best setting of this mainboard but these values are qualified by the AOpen RD and QA department as the reliable settings especially if you have limited loading of add-on card and memory size (for example, a system that contains only a VGA/Sound card and two SIMMs).

To attain the best system performance, you may manually set the parameters in the "Chipset Features Setup" to get proprietary setting. Make sure that you know and understand the functions of every item in Chipset Setup menu. The performance difference of Turbo from Optimal is normally around 3% to 10%, depending on the chipset and the application.

3.9 Integrated Peripherals

The following screen appears if you select the option "Integrated Peripherals" from the main menu. This option allows you to configure the I/O features.

```

ROM PCI/ISA BIOS (00000006)
INTEGRATED PERIPHERALS
AWARD SOFTWARE, INC.

IDE HDD Block Mode      : Enabled
IDE Primary Master PIO  : Auto
IDE Primary Slave PIO   : Auto
IDE Secondary Master PIO: Auto
IDE Secondary Slave PIO : Auto
IDE Primary Master UDMA : Auto
IDE Primary Slave UDMA  : Auto
IDE Secondary Master UDMA: Auto
IDE Secondary Slave UDMA: Auto
On-Chip Primary PCI IDE: Enabled
On-Chip Secondary PCI IDE: Enabled
USB Legacy Support      : Disabled
USB IRQ Released       : No

Onboard FDC Controller  : Enabled
Onboard Serial Port 1   : Auto
Onboard Serial Port 2   : Auto
Onboard UART 2 Mode     : Standard
Onboard Parallel Port   : 378/IRQ7
Parallel Port Mode      : SPP

***** Hardware Monitor *****
CPU Thermal (Temp.)    : Ignore

ESC : Quit      ↑↓←→ : Select Item
F1  : Help      PU/PD/+/- : Modify
F5  : Old Values (Shift)F2 : Color
F6  : Load Setup Defaults
F7  : Load Turbo Defaults
    
```

Integrated Peripherals à IDE HDD Block Mode

<u>IDE HDD Block Mode</u>
Enabled
Disabled

This feature enhances disk performance by allowing multisector data transfers and eliminates the interrupt handling time for each sector. Most IDE drives, except with old designs, can support this feature.

AWARD BIOS

Integrated Peripherals à IDE Primary Master PIO

Integrated Peripherals à IDE Primary Slave PIO

Integrated Peripherals à IDE Secondary Master PIO

Integrated Peripherals à IDE Secondary Slave PIO

IDE Primary Master

PIO

Auto

Mode 1

Mode 2

Mode 3

Mode 4

Setting this item to **Auto** activates the HDD speed auto-detect function. The PIO mode specifies the data transfer rate of HDD. For example: mode 0 data transfer rate is 3.3MB/s, mode 1 is 5.2MB/s, mode 2 is 8.3MB/s, mode 3 is 11.1MB/s and mode 4 is 16.6MB/s. If your hard disk performance becomes unstable, you may manually try the slower mode.



Caution: *It is recommended that you connect the first IDE device of each channel to the endmost connector of the IDE cable. Refer to section 2.3 "Connectors" for details on how to connect IDE device(s).*

Integrated Peripherals à IDE Primary Master UDMA

Integrated Peripherals à IDE Primary Slave UDMA

Integrated Peripherals à IDE Secondary Master UDMA

Integrated Peripherals à IDE Secondary Slave UDMA

IDE Primary Master

UDMA

Auto

Disabled

This item allows you to set the Ultra DMA/33 mode supported by the hard disk drive connected to your primary IDE connector.

Integrated Peripherals à On-Chip Primary PCI IDE

Integrated Peripherals à On-Chip Secondary PCI IDE

On-Chip Primary

PCI IDE

Enabled

Disabled

This parameter lets you enable or disable the IDE device connected to the primary IDE connector.

Integrated Peripherals à USB Legacy Support

USB Legacy Support

Enabled
Disabled

This item lets you enable or disable the USB keyboard driver within the onboard BIOS. The keyboard driver simulates legacy keyboard command and let you use USB keyboard during POST or after boot if you don't have USB driver in the operating system.



Caution: *You can not use both USB driver and USB legacy keyboard at the same time. Disable "USB Legacy Support" if you have USB driver in the operating system.*

Integrated Peripherals à USB IRQ Released

USB IRQ Released

Yes
No

USB device is default to use PCI INTD#, the same as PCI slot4. If you installed PCI card on slot4 and require to use INTD#, set this item to Yes. The USB device will then be disabled.



Note: *Normally, PCI VGA does not need PCI interrupt, you may put PCI VGA on slot4.*

Integrated Peripherals à Onboard FDC Controller

Onboard FDC Controller

Enabled
Disabled

Setting this parameter to **Enabled** allows you to connect your floppy disk drives to the onboard floppy disk connector instead of a separate controller card. Change the setting to Disabled if you want to use a separate controller card.

AWARD BIOS

Integrated Peripherals à Onboard Serial Port 1 Integrated Peripherals à Onboard Serial Port 2

<u>Onboard Serial Port 1</u>
Auto
3F8/IRQ4
2F8/IRQ3
3E8/IRQ4
2E8/IRQ3
Disabled

This item allow you to assign address and interrupt for the board serial port. Default is **Auto**.



Note: *If you are using an network card, make sure that the interrupt does not conflict.*

Integrated Peripherals à Onboard UART 2 Mode

<u>Onboard UART 2 Mode</u>
Standard
HPSIR
ASKIR

This item is configurable only if the "Onboard **UART 2**" is enabled. This allows you to specify the mode of serial port2. The available mode selections are:

- **Standard** - Sets serial port 2 to operate in normal mode. This is the default setting.
- **HPSIR** - Select this setting if you installed an Infrared module in your system via IrDA connector (refer to section 2.3 "Connectors"). This setting allows infrared serial communication at a maximum baud rate of 115K baud.
- **ASKIR** - Select this setting if you installed an Infrared module via IrDA connector (refer to section 2.3 "Connectors"). This setting allows infrared serial communication at a maximum baud rate of 19.2K baud.

Integrated Peripherals à Onboard Parallel Port

Onboard Parallel

Port

3BC/IRQ7

378/IRQ7

278/IRQ5

Disabled

This item controls the onboard parallel port address and interrupt.



Note: If you are using an I/O card with a parallel port, make sure that the addresses and IRQ do not conflict.

Integrated Peripherals à Parallel Port Mode

Parallel Port Mode

SPP

EPP

ECP

ECP + EPP

This item lets you set the parallel port mode. The mode options are **SPP** (Standard Parallel Port), **EPP** (Enhanced Parallel Port) and **ECP** (Extended Parallel Port). SPP is the IBM AT and PS/2 compatible mode. EPP enhances the parallel port throughput by directly writing/reading data to/from parallel port without latch. ECP supports DMA and RLE (Run Length Encoded) compression and decompression.

Integrated Peripherals à ECP Mode Use DMA

ECP Mode Use DMA

3

1

This item lets you set the DMA channel of ECP mode.

Integrated Peripherals à CPU Thermal (Temp.)

CPU Thermal

(Temp.)

Ignore

Monitor

This function lets you control the **Thermal Detection** function. When you set this option to Monitor and the temperature of CPU exceeds predefined value, then:

1. The PC speaker will beep 5 times.
2. The CPU cycle timer will descend about 35%.



Note: The CPU cycle timer won't be restored to the original status until you reset the system.

3.10 Password Setting

Password prevents unauthorized use of your computer. If you set a password, the system prompts for the correct password before boot or access to Setup.

To set a password:

1. At the prompt, type your password. Your password can be up to 8 alphanumeric characters. When you type the characters, they appear as asterisks on the password screen box.
2. After typing the password, press <Enter> key.
3. At the next prompt, re-type your password and press again to confirm the new password. After the password entry, the screen automatically reverts to the main screen.

To disable the password, press when prompted to enter the password. The screen displays a message confirming that the password has been disabled.

3.11 IDE HDD Auto Detection

If your system has an IDE hard drive, you can use this function to detect its parameters and enter them into the "Standard CMOS Setup" automatically.

This routine only detects one set of parameters for your IDE hard drive. Some IDE drives can use more than one set of parameters. If your hard disk is formatted using different parameters than those detected, you have to enter the parameters manually. If the parameters listed do not match the ones used to format the disk, the information on that disk will not be accessible. If the auto-detected parameters displayed do not match those that used for your drive, ignore them. Type N to reject the values and enter the correct ones manually from the Standard CMOS Setup screen.

3.12 Save & Exit Setup

This function automatically saves all CMOS values before leaving Setup.

3.13 Exit without Saving

Use this function to exit Setup without saving the CMOS value changes. Do not use this option if you want to save the new configuration.

3.14 NCR SCSI BIOS and Drivers

The NCR 53C810 SCSI BIOS resides in the same flash memory chip as the system BIOS. The onboard NCR SCSI BIOS is used to support NCR 53C810 SCSI control card without BIOS code.

The NCR SCSI BIOS directly supports DOS, Windows 3.1 and OS/2. For better system performance, you may use the drivers that come with the NCR SCSI card or with your operating system. For details, refer to the installation manual of your NCR 53C810 SCSI card.

3.15 BIOS Flash Utility

The BIOS Flash utility allows you upgrade the system BIOS. To get the AOpen Flash utility and the upgrade BIOS file, contact your local distributor or visit our homepage at <http://www.aopen.com.tw>. Please make sure that you have the correct BIOS ready, the BIOS filename is normally like AP5TC110.BIN, which means model AP5TC BIOS revision 1.10.

There are two useful programs, Checksum utility CHECKSUM.EXE and AOpen Flash utility AOFLASH.EXE. Follow the procedures below to upgrade your BIOS.

[CHECKSUM.EXE]

This utility will help you to determine if the BIOS has been downloaded correctly or not.

1. Execute

```
C:> CHECKSUM Biosfile.bin
```

(Where Biosfile.bin indicates the file name of the BIOS code.)

2. The utility will show "Checksum is ssss".

3. Compare the "sss" with original checksum posted on Web or BBS. If they are different, please do not proceed any further and try to download the BIOS again.

[AOFLASH.EXE]

This utility will try to check the mainboard model, BIOS version and Super/Ultra IO chip model. To ensure the correct BIOS file for the correct mainboard and IO chip. This utility will permanently replace your original BIOS content after flashing.

1. Bootup the system from DOS prompt without loading any memory manager (HIMEM, EMM386, QEMM386, ...).

2. Execute

```
C:> AOFLASH Biosfile.bin
```

(Where Biosfile.bin indicates the file name of the BIOS code.)

3. After loading the new BIOS code, the utility will prompt you to save original BIOS code into your HDD or floppy. Please press "Y" to store it as "BIOS.OLD".

4. After the old BIOS has been successfully saved, press "Y" to replace BIOS.

5. DO NOT turn off the power during "FLASHING".
6. Reboot the system by turn off the power after "FLASHING".
7. Press "DEL" key to enter BIOS setup during POST.
8. Reload the "BIOS SETUP DEFAULT" and reconfigure other items as previous set.
9. Save & Exit. Done!



Warning: DO NOT turn off the power during "FLASHING". If the BIOS programming is not successfully finished, the system will not be boot again, and you may need to physically replace the BIOS chip.



Tip: You may load back original BIOS "BIOS.OLD" by the same procedure.

Appendix A

Frequently Asked Question



Note: FAQ may be updated without notice. If you cannot find the information that you need in this appendix, visit our WWW home page, (address: <http://www.aopen.com.tw>) and check the FAQ area and other new information.

Q: How can I identify the mainboard BIOS version?

A: The AOpen mainboard BIOS version appears on the upper-left corner of the POST (Power-On Self Test) screen. Normally, it starts with R and is found in between the model name and the date. For example:

AP53/AX53 R3.80 Oct.22.1996

↖
BIOS revision

Q: How can I identify version of the mainboard?

A: The AOpen mainboard revision appears as Rev x.x on the PCB, near the PCI slot. For example, for AP5T revision 3.4, the revision number appears on the PCB as follows:

AP5T MB
Rev 3.4

↖ AP5T revision 3.4

Frequently Asked Questions

Q: Why the AOpen mainboards (MB) do not have cache module expansion slot?

A: Faster CPU speed requires more difficult and complex MB timing design. Every trace and components delay must be taken into consideration. The expansion cache slot design will cause 2 or 3ns delay in PBSRAM timing, and the extended trace length to the cache module through the golden finger will further delay the timing by 1 or 2ns. This may result in unreliable system once the cache module and slot becomes worn. All AOpen MBs support 512KB PBSRAM onboard. For better performance (around 3% higher than 256KB), we strongly recommend you to use 512KB onboard. Otherwise, reliable 256KB is better than unreliable 512KB with cache module. AOpen is the first company to promote this concept since the fourth quarter of 1995.

Q: What is FCC DoC (Declaration of Conformity)?

A: The DoC is new certification standard of FCC regulations. This new standard allows DIY component (such as mainboard) to apply DoC label separately without a shielding of housing. The rule to test mainboard for DoC is to remove housing and test it with regulation 47 CFR 15.31. The DoC test of mainboard is more difficult than traditional FCC test. If the mainboard passes DoC test, that means it has very low EMI radiation and you can use any kind of housing (even paper housing). Following is an example of DoC label.

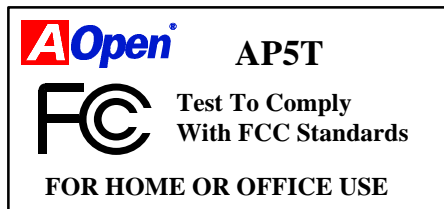

Q: Can SDRAM DIMM work together with FPM/EDO SIMM?

A: The FPM/EDO operate at 5V while SDRAM operates at 3.3V. The current MB design provides different power to DIMM and SIMM but connects the data bus together. If you combine SIMM and DIMM, the system will still work fine; however, only temporarily. After a few months, the SDRAM 3.3V data input will be damaged by 5V FPM/EDO data output line. Therefore, we strongly NOT recommend DIMM and SIMM combined together. There is one exception, if your SDRAM supports 5V tolerance (such as TI or Samsung), which accepts 5V signal at 3.3V operating power, you can combine them.

Frequently Asked Question

Manufacturer	Model	Suggested CAS Latency Time	5V Tolerance
Samsung	KM416511220AT-G12	2	Yes
NEC	D4S16162G5-A12-7JF	2	No
Hitachi	HM5216805TT10	2	No
Fujitsu	81117822A-100FN	2	No
TI	TMX626812DGE-12	2	Yes
TI	TMS626812DGE-15	3	Yes
TI	TMS626162DGE-15	3	Yes
TI	TMS626162DGE-M67	3	Yes

Q: What is Bus Master IDE (DMA mode)?

A: The traditional PIO (Programmable I/O) IDE requires the CPU to involve in all the activities of the IDE access including waiting for the mechanical events. To reduce the workload of the CPU, the bus master IDE device transfers data from/to memory without interrupting CPU, and releases CPU to operate concurrently while data is transferring between memory and IDE device. You need the bus master IDE driver and the bus master IDE HDD to support bus master IDE mode. Note that it is different with master/slave mode of the IDE device connection. For more details, refer to section 2.3 "Connectors".

Q: What is 3.3V Over-current Protection?

A: The Over-current Protection was very popular implemented on the Baby AT or ATX +5V/+12V switching power supply. It is very useful to prevent accident short circuit when you install the mainboard, HDD, add-on cards into housing. But unfortunately, the new generation CPU and chipset use 3.3V or 2.8V voltage which has regulator to transfer 5V to 3.3V/2.8V, and makes 5V over-current protection useless. AOpen TX mainboard AP5T/AX5T with switching regulator onboard support 3.3V (Vcpuio, chipset, PBSRAM, SDRAM) and 2.8V (CPU Vcore) over-current protection, in conjunction with 5V/12V power supply provide the full line over-current protection.

Q: What is CPU Thermal Protection?

A: The higher speed of CPU, the more heat dissipation need to be taking into consideration. If user does not use correct fan for the CPU cooling, it is highly possible the CPU can over heat and causing system unstable. AOpen AP5T/AX5T/AX6F has special thermal detection circuit under the

Frequently Asked Questions

CPU, and slow down the CPU speed as well as warning when temperature is high then a predefined temperature. (Normally, 55 degree C.)

Q: What is the Ultra DMA/33?

A: This is the new specification to improve IDE HDD data transfer rate. Unlike traditional PIO mode, which only uses the rising edge of IDE command signal to transfer data, the DMA/33 uses both rising edge and falling edge. Hence, the data transfer rate is double of the PIO mode 4 or DMA mode 2. (16.6MB/s x2 = 33MB/s).

The following table lists the transfer rate of IDE PIO and DMA modes. The IDE bus is 16-bit, which means every transfer is two bytes.

Mode	Clock per 33MHz PCI	Clock count	Cycle time	Data Transfer rate
PIO mode 0	30ns	20	600ns	$(1/600\text{ns}) \times 2\text{byte} = 3.3\text{MB/s}$
PIO mode 1	30ns	13	383ns	$(1/383\text{ns}) \times 2\text{byte} = 5.2\text{MB/s}$
PIO mode 2	30ns	8	240ns	$(1/240\text{ns}) \times 2\text{byte} = 8.3\text{MB/s}$
PIO mode 3	30ns	6	180ns	$(1/180\text{ns}) \times 2\text{byte} = 11.1\text{MB/s}$
PIO mode 4	30ns	4	120ns	$(1/120\text{ns}) \times 2\text{byte} = 16.6\text{MB/s}$
DMA mode 0	30ns	16	480ns	$(1/480\text{ns}) \times 2\text{byte} = 4.16\text{MB/s}$
DMA mode 1	30ns	5	150ns	$(1/150\text{ns}) \times 2\text{byte} = 13.3\text{MB/s}$
DMA mode 2	30ns	4	120ns	$(1/120\text{ns}) \times 2\text{byte} = 16.6\text{MB/s}$
DMA/33	30ns	4	120ns	$(1/120\text{ns}) \times 2\text{byte} \times 2 = 33\text{MB/s}$

Frequently Asked Question

Q: What is the performance of Ultra DMA/33? Do we need special driver?

A: You need driver to activate DMA/33, there are now driver from INTEL or you can use driver in the Windows 95 Memphis, which can recognize South Bridge PIIX4.

We got the mass production sample Quantum Fireball ST1.6A, following are the test result.

MB : AOpen AP5T
CPU : P54C-200 Mhz
DRAM : 16MB * 2 (FP-7)
VGA : AOpen PV60
CDROM : AOpen CD-920E (20X)
OS : Win95 OSR2

Model	OS/Driver	Mode	Winbench97 Disk Winmark (Business)	Winbench97 Disk Winmark (High End)
Quantum Fireball 1.2G	Windows 95 OSR2	PIO mode 4	717	2150
Quantum Fireball 1.2G	Windows 95 OSR2 + INTEL PIIX4 driver	DMA mode 2	822	3050
Quantum ST1.6A	Windows 95 OSR2	PIO mode 4	853	2630
Quantum ST1.6A	Windows 95 OSR2 + INTEL PIIX4 driver	DMA/33	1040	4020

Frequently Asked Questions

Q: What is the memory performance improvement of TX chipset?

A: Following is the compare table of TX+SDRAM, VX+SDRAM, TX+EDO, HX+EDO and VX+EDO.

- CPU : Pentium PP/MT (P55C) 200MHz
- DRAM :16MB EDO or SDRAM
- HDD : Quantum Fireball 1280AT
- VGA : AOpen PV60 S3 Trio64V+ 800x600x256 Small font
- OS : Windows 95 OSR2

Chipset	Model	DRAM	Timing	Winstone96
Intel 430VX	AP5VM	EDO	6-2-2-2	86.1
Intel 430HX	AP53/AP5K	EDO	5-2-2-2	86.8
Intel 430TX	AP5T/AX5T	EDO	5-2-2-2	87.3
Intel 430VX	AP5VM/AP5V	SDRAM	6-1-1-1	86.6
Intel 430TX	AP5T/AX5T	SDRAM	5-1-1-1	87.7

Q: Power Management Icon does not appear in the Windows 95 Control Panel even though the APM under BIOS Setup is enabled.

A: This problem occurs if you did not enable the APM function before you install Windows 95. If you have already installed Windows 95, re-install it after the BIOS APM function is enabled.

Frequently Asked Question

Q: Why does the system fail to go into suspend mode under Win95?

A: This problem may be caused by your CDROM settings. The CDROM Auto Insert Notification of Win95 is default enabled, the system will continue to monitor your CDROM, auto-execute application when a CD diskette is loaded, and prevents the system from entering into suspend mode. To resolve this, go into Control Panel → System → Device Manager → CDROM → Setting, and disable the "Auto Insert Notification" function.

Q: How can I eliminate the "?" marks presented under Device Manager after installing Win'95 on TX or LX based system?

A: Although your system will still work fine with this "?" exist. We received many requests about how to eliminate it. AOpen software team spends few weeks to develop an utility AOchip.exe for convenience of Win95 users. It is very user friendly and can be used on any TX or LX motherboard, not limited to Aopen's products. You are welcome to distribute it, if you like it, simply say thanks to our software team. Note that you need USB driver for USB devices to work properly, which is expected to be implemented on Windows'98.

Q: Why are there question marks or "standard IDE controller" presented under Device Manager after installing Win'95 on TX or LX based system?

A: Intel has introduced 430TX or 440LX chipset with latest feature of "ACPI", "USB" & "Ultra DMA/33". Since these devices are so new that Win'95 did not anticipate to support them on Aug. of '95 which Win'95 initially is being released. To eliminate, you may run AOchip.exe developed by AOpen software team. Drivers for above new features are expected to be implemented in Windows'98.

Frequently Asked Questions

Q: How to install Windows 95 USB driver?

A: If you are Win'95 OSR 2.0 user (.950B, shows "PCI Universal Serial Devices"), you may obtain USBSUPP.EXE from Microsoft or your OEM system provider for installing Microsoft USB supplement which will create "USB Supplement to OSR2" in the list of Add/Remove program tool under Control Panel. After above installation, please run AOchip.exe provided by AOpen to create USB Controller under Device Manager.

If you are Win'95 OSR 2.1 user, only AOchip.exe installation is necessary.

If you are Win'95 retail user (.950 or .950A), there is no direct upgrade path available from Microsoft at this moment. It is expected to be implemented under Windows'98.

Q: Which version of the Windows '95 that I am using?

A: You may determine the version of Windows '95 by following steps.

1. Double click "System" in "Control Panel".
2. Click "General".
3. Look for "System" heading & refer to following,

4.00.950	Windows 95
4.00.950A	Windows 95 + Service Pack or OEM Service Release 1
4.00.950B	OEM Service Release 2 or OEM Service Release 2.1

If you are running OSR 2.1, you may tell it from by checking "USB Supplement to OSR2" in the list of installed program of Add/Remove program tool under Control Panel, and checking for version 4.03.1212 of the Ntkern.vxd file in the Windows\System\Vmm32 folder.

Q: What is LDCM (LAN Desktop Client Manager)?

A: This is a software of Intel. The major goal is to provide an easy way for corporate network administrator to monitor the status of all the clients (workstation). You need at least DMI BIOS for LDCM. AOpen BIOS is also DMI ready but unfortunately, Intel LDCM needs Intel network card to work properly. It is obviously not suitable for home user to pay LDCM extra cost.

Frequently Asked Question

Q: What is ADM (Advanced Desktop Manager)?

A: This is a desktop client and server management software developed by AOpen. It is similar as Intel LDCM with some improvement. ADM is not only for corporate network management, it can also be used as system status monitoring utility, for example, CPU fan, thermal and system voltage monitoring.

Features	ADM 2.0	LDCM 3.0
VGA card	No limitation	Only ATI
Network card	No limitation	Only Intel
Support DMI BIOS 2.0	Yes	Yes
Support Win95	Yes	Yes
Support Win NT	No (will be supported on ADM 2.1)	Yes
Real-Time CPU/Memory Utilization Monitoring	Yes	No
Multi-Machine Monitoring on One Screen	Yes	No
Remote Management Protocol	Standard SNMP protocol	Intel proprietary RAP protocol
Standard SNMP Trap	Yes (so that can work with standard software such as HP Open View)	No
Remote File Transfer	No	Yes

Appendix B

Troubleshooting

In case you encounter any of the troubles listed below, follow the procedures accordingly to resolve the problem. If the first corrective action listed did not work, then try the next one.



Important: Make sure that you have tried listed procedures in this appendix before you call your distributor.



Tip: There are many useful information in our homepage, such as jumper settings, latest BIOS, drivers, and more FAQs. Visit our homepage to see if there is answer of your problem.

Taiwan <http://www.aopen.com.tw>

USA <http://www.aopen-usa.com>

<http://www.aopenamerica.com>

Europe <http://www.aopen.nl>

No display

1. Check all jumper settings according to section 2.2 "Jumpers". Make sure that you have set the proper jumpers especially those for CPU frequency, core and IO voltage select functions. Ask your CPU dealer for the correct CPU specifications.
2. Check the power cord or power switch of your system. The simple way to identify power failure is to check the CPU fan and the power supply fan. If these are not working, then the power is down.
3. Turn off the power and remove all add-on cards, connectors and SIMMs from your mainboard. Then reinstall the VGA card and two SIMMs. Turn on the power again. If you can see the POST (power-on-self-test) screen,

Troubleshooting

the problem is your add-on cards or peripheral. try to reinstall the add-on cards one by one to find out which card is causing the problem.

4. Check the monitor and VGA cable. Press the <Num Lock> key to enable/disable the Num Lock function. If the Num Lock LED works properly, this indicates that your CPU, SIMM and BIOS bootup sequence are properly functioning. The problem may be caused by your VGA or monitor.

Unstable system or HDD, HDD with bad sector. System sometimes hangs or auto reboots.

1. Check all jumper settings according to section 2.2 "Jumpers". Make sure that you have set the proper jumpers especially those for CPU frequency, core and IO voltage select functions. Ask your CPU dealer for correct CPU specification. The remarked CPU is very popular in the market, we recommend that you use a Box CPU, i.e., CPU sold in package with warranty card inside.
2. Check if your SIMM has less than 24 chips. Refer to section 2.4 "Configuring the System Memory" for details.
3. Set DRAM timing to 70ns and disable all enhanced chipset features in BIOS. The default BIOS timing is 60ns for better performance. If you are using an old SIMM or a remarked SIMM, you may need to manually slow down the DRAM timing and disable the chipset features. Refer to chapter 3 "Chipset Features Setup" for details.
4. Disable the power management and USB functions. Some add-on cards, drivers or applications may not be compatible with these functions.
5. Disable the external cache (2nd level cache) in chapter 3 "Advanced CMOS Setup" (AMI) or "BIOS Features Setup" (AWARD). If the system works fine, your cache module or onboard PBSRAM may be malfunction.
6. Enter BIOS and set the HDD "Block" and "32-bit" mode parameters to OFF. Refer to Chapter 3 "Standard CMOS Setup" (AMI) or "Integrated Peripherals" (AWARD) for details. Also, if possible set HDD PIO mode 2 or 3 to a slower transfer speed.
7. Turn off the power and remove all add-on cards, connectors and SIMMs from your mainboard. Then reinstall the VGA card, two SIMMs and connect only one hard disk to the end-most connector of the IDE cable. The IDE cable length must not exceed 46cm (18inches), refer to section 2.3 "Connectors". If the system functions properly, reinstall the add-on cards one by one. This will help you find out which card or device is causing the problem. Be sure to connect the 2nd IDE device (HDD/CD-ROM) to the primary channel slave mode.

8. If your CPU bus frequency is 66MHz, set the CPU external/bus frequency to 60MHz, but leave the CPU core/bus frequency ratio unchanged. Normally, CPU with 66MHz bus frequency works properly at slower speed, e.g., 60MHz. This will help you identify if the CPU is remarked or if the mainboard or add-on card is unstable at 66MHz.

Keyboard, Mouse, Printer or Floppy is not working properly.

1. Check the cable and bracket. Make sure that pin 1 of the cable is connected to pin1 of the connector. Pin 1 of the flat cable is indicated by a red-colored wire. Refer to section 2.3 "Connectors".
2. If possible, use another system to test the peripherals and cables. Check if these are working properly.
3. If possible, use another peripheral to double check if the mainboard or the cable is defective.

CMOS data lost, forget password.

1. Refer to section 2.2 "Jumpers". Locate the CMOS jumper and follow the procedures on how to clear the CMOS. Load the BIOS optimal settings (AMI) or load BIOS default settings (Award).
2. If your mainboard comes with a battery, simply change it. If your mainboard comes with Dallas DS12887A compatible RTC, the occurrence of low battery problem is very rare since RTC battery is expected to last for 7 years. In this case, you have to send the mainboard back to your distributor.

Incompatible add-on card, peripheral, operating system, and application.

1. Check all jumper settings according to section 2.2 "Jumpers".
2. Check if you have a Legacy ISA card (non PnP). If yes, set the IRQ and DMA for this card to Legacy/ISA. Refer to Chapter 3 "PCI/PnP Setup" section. If you are using a PnP operating system such as Win95, enable the "Plug-and-Play Aware O/S" parameter in BIOS and let the OS configure the system.
3. Disable all enhanced chipset features. Refer to Chapter 3 "Chipset Features Setup" for details.
4. Disable the power management and USB functions. Some add-on cards, drivers or applications are not compatible with these functions.

Troubleshooting

5. Disable the external cache (2nd level cache) and system BIOS cacheable or VGA BIOS cacheable parameters in BIOS. Refer to Chapter 3 "Advanced CMOS Setup" section. Some applications has trouble at higher system speed.
6. Visit our WWW home page, (address <http://www.aopen.com.tw>), check the FAQ area (frequently asked question) and download the latest BIOS, try again with the latest BIOS.



Important: *If problem still exist after you have done all the corrective actions listed in this appendix, fill out the attached problem report form. Write down your configuration and error symptoms as detailed as possible. The more detailed information you give us, the faster we can identify and solve your problem. You can copy this form and fax it to your distributor or send the form via e-mail. Refer to Appendix B "Frequently Asked Question" for information on how to identify the BIOS and the mainboard versions.*

Technical Problem Report Form											
FROM:	Name: _____ TEL: _____ FAX: _____ Email address: _____										
Error Symptom:											
Error Type: (Please mark in the box and list the model and version below.)	<table style="width: 100%; border: none;"> <tr> <td style="width: 50%; vertical-align: top;"> <input type="checkbox"/> PS/2 mouse <input type="checkbox"/> Printer <input type="checkbox"/> Floppy <input type="checkbox"/> IDE HDD <input type="checkbox"/> Keyboard <input type="checkbox"/> Sound/Modem <input type="checkbox"/> SCSI CDROM <input type="checkbox"/> Ethernet <input type="checkbox"/> USB <input type="checkbox"/> Win95 <input type="checkbox"/> Window NT <input type="checkbox"/> UNIX </td> <td style="width: 50%; vertical-align: top;"> <input type="checkbox"/> COM1/COM2, serial mouse. <input type="checkbox"/> Parallel Tape <input type="checkbox"/> Floppy Tape <input type="checkbox"/> IDE CDROM <input type="checkbox"/> VGA <input type="checkbox"/> SCSI HDD <input type="checkbox"/> SCSI Tape <input type="checkbox"/> Tokenring <input type="checkbox"/> DOS <input type="checkbox"/> Windows 3.1 <input type="checkbox"/> OS/2 <input type="checkbox"/> Others: _____ </td> </tr> </table>	<input type="checkbox"/> PS/2 mouse <input type="checkbox"/> Printer <input type="checkbox"/> Floppy <input type="checkbox"/> IDE HDD <input type="checkbox"/> Keyboard <input type="checkbox"/> Sound/Modem <input type="checkbox"/> SCSI CDROM <input type="checkbox"/> Ethernet <input type="checkbox"/> USB <input type="checkbox"/> Win95 <input type="checkbox"/> Window NT <input type="checkbox"/> UNIX	<input type="checkbox"/> COM1/COM2, serial mouse. <input type="checkbox"/> Parallel Tape <input type="checkbox"/> Floppy Tape <input type="checkbox"/> IDE CDROM <input type="checkbox"/> VGA <input type="checkbox"/> SCSI HDD <input type="checkbox"/> SCSI Tape <input type="checkbox"/> Tokenring <input type="checkbox"/> DOS <input type="checkbox"/> Windows 3.1 <input type="checkbox"/> OS/2 <input type="checkbox"/> Others: _____								
<input type="checkbox"/> PS/2 mouse <input type="checkbox"/> Printer <input type="checkbox"/> Floppy <input type="checkbox"/> IDE HDD <input type="checkbox"/> Keyboard <input type="checkbox"/> Sound/Modem <input type="checkbox"/> SCSI CDROM <input type="checkbox"/> Ethernet <input type="checkbox"/> USB <input type="checkbox"/> Win95 <input type="checkbox"/> Window NT <input type="checkbox"/> UNIX	<input type="checkbox"/> COM1/COM2, serial mouse. <input type="checkbox"/> Parallel Tape <input type="checkbox"/> Floppy Tape <input type="checkbox"/> IDE CDROM <input type="checkbox"/> VGA <input type="checkbox"/> SCSI HDD <input type="checkbox"/> SCSI Tape <input type="checkbox"/> Tokenring <input type="checkbox"/> DOS <input type="checkbox"/> Windows 3.1 <input type="checkbox"/> OS/2 <input type="checkbox"/> Others: _____										
System Configuration: (Please list model name and version.)	<table style="width: 100%; border: none;"> <tr> <td style="width: 50%;">MB: _____</td> <td style="width: 50%;">BIOS: _____</td> </tr> <tr> <td>CPU: _____</td> <td>SIMM: _____</td> </tr> <tr> <td>HDD: _____</td> <td>CDROM: _____</td> </tr> <tr> <td>VGA: _____</td> <td>OS: _____</td> </tr> <tr> <td colspan="2">Others: _____</td> </tr> </table>	MB: _____	BIOS: _____	CPU: _____	SIMM: _____	HDD: _____	CDROM: _____	VGA: _____	OS: _____	Others: _____	
MB: _____	BIOS: _____										
CPU: _____	SIMM: _____										
HDD: _____	CDROM: _____										
VGA: _____	OS: _____										
Others: _____											

Appendix C

Jumper Table Summary

Setting the CPU Voltage

<u>S4</u>	<u>S5</u>	<u>S6</u>	<u>S7</u>	<u>S8</u>	<u>CPU Core Voltage</u>
ON	ON	ON	ON	OFF	3.52V (Cyrix 6x86 or AMD K5)
OFF	ON	ON	ON	OFF	3.45V (Intel P54C or IDT C6)
OFF	OFF	ON	ON	OFF	3.2V (AMD K6-233)
ON	OFF	OFF	ON	OFF	2.9V (K6-166/200 or M2)
OFF	OFF	OFF	ON	OFF	2.8V (Intel P55C)
OFF	ON	OFF	OFF	OFF	2.2V (AMD K6-266/300)
OFF	ON	OFF	ON	ON	1.8V (For future use)

<u>JP12</u>	<u>I/O Voltage (Vio)</u>
1-2	3.45V (default)
3-4	3.52V



Warning: Please make sure that you have installed CPU fan properly if Intel PP/MT-233 or AMD K6-200/233 is being selected to use. It may cause your system unstable if you can not meet the heat dissipation requirement from above CPU type. It is recommended to adopt larger fan on these CPU for better air flow in the system.



Tip: Normally, for single voltage CPU, Vcpuio (CPU I/O Voltage) is equal to Vcore, but for CPU that needs dual voltage such as PP/MT (P55C) or Cyrix 6x86L, Vcpuio is different from Vcore and must be set to Vio (PBSRAM and Chipset Voltage). The single or dual voltage CPU is automatically detected by hardware circuit.

CPU	Type	S4	S5	S6	S7	S8	Vcore
-----	------	----	----	----	----	----	-------

Jumper Table Summary

INTEL P54C	Single Voltage	OFF	ON	ON	ON	OFF	3.45V
INTEL MMX P55C	Dual Voltage	OFF	OFF	OFF	ON	OFF	2.8V
AMD K5	Single Voltage	ON	ON	ON	ON	OFF	3.52V
AMD K6-166/200	Dual Voltage	ON	OFF	OFF	ON	OFF	2.9V
AMD K6-233	Dual Voltage	OFF	OFF	ON	ON	OFF	3.2V
AMD K6-266/300	Dual Voltage	OFF	ON	OFF	OFF	OFF	2.2V
Cyrix 6x86	Single Voltage	ON	ON	ON	ON	OFF	3.52V
Cyrix 6x86L	Dual Voltage	OFF	OFF	OFF	ON	OFF	2.8V
Cyrix M2	Dual Voltage	ON	OFF	OFF	ON	OFF	2.9V
IDT C6	Single Voltage	OFF	ON	ON	ON	OFF	3.45V

Selecting the CPU Frequency

<u>S1</u>	<u>S2</u>	<u>S3</u>	<u>CPU Frequency Ratio</u>	<u>JP4</u>	<u>JP5</u>	<u>JP6</u>	<u>CPU External Clock</u>
OFF	OFF	OFF	1.5x (3.5x)	1-2	2-3	1-2	60MHz
ON	OFF	OFF	2x	2-3	1-2	1-2	66MHz
ON	ON	OFF	2.5x (1.75x)	1-2	2-3	2-3	75MHz
OFF	ON	OFF	3x	2-3	1-2	2-3	83.3MHz
ON	OFF	ON	4x				
ON	ON	ON	4.5x				
OFF	ON	ON	5x				



Note: Intel PP/MT MMX 233MHz is using 1.5x jumper setting for 3.5x frequency ratio, and AMD PR166 is using 2.5x setting for 1.75x frequency ratio.



Warning: INTEL TX chipset supports only 60/66MHz external CPU bus clock, the 75/83.3MHz settings are for internal test only, **set to 75/83.3MHz exceeds the specification of TX chipset, which may cause serious system damage.**



Warning: Cyrix 6x86 P200+ uses 75MHz external clock, the jumper setting shown on the table below is for user's convenient. It may cause serious system damage to use 75MHz clock.



Warning: Although you may set 75MHz x 2 for Cyrix MX-PR200 and 83.3MHz x 2 for Cyrix MX-PR233, note that 75/83.3MHz settings may probably cause serious system damage.

INTEL Pentium	CPU Core Frequency	Ratio	External Bus Clock	S1	S2	S3	JP4 & JP5 & JP6
---------------	--------------------	-------	--------------------	----	----	----	-----------------

Jumper Table Summary

P54C 90	90MHz =	1.5x	60MHz	OFF	OFF	OFF	1-2 & 2-3 & 1-2
P54C 100	100MHz =	1.5x	66MHz	OFF	OFF	OFF	2-3 & 1-2 & 1-2
P54C 120	120MHz =	2x	60MHz	ON	OFF	OFF	1-2 & 2-3 & 1-2
P54C 133	133MHz =	2x	66MHz	ON	OFF	OFF	2-3 & 1-2 & 1-2
P54C 150	150MHz =	2.5x	60MHz	ON	ON	OFF	1-2 & 2-3 & 1-2
P54C 166	166MHz =	2.5x	66MHz	ON	ON	OFF	2-3 & 1-2 & 1-2
P54C 200	200MHz =	3x	66MHz	OFF	ON	OFF	2-3 & 1-2 & 1-2

INTEL Pentium MMX	CPU Core Frequency	Ratio	External Bus Clock	S1	S2	S3	JP4 & JP5 & JP6
PP/MT 150	150MHz =	2.5x	60MHz	ON	ON	OFF	1-2 & 2-3 & 1-2
PP/MT 166	166MHz =	2.5x	66MHz	ON	ON	OFF	2-3 & 1-2 & 1-2
PP/MT 200	200MHz =	3x	66MHz	OFF	ON	OFF	2-3 & 1-2 & 1-2
PP/MT 233	233MHz =	3.5x	66MHz	OFF	OFF	OFF	2-3 & 1-2 & 1-2

Cyrix 6x86 & 6x86L	CPU Core Frequency	Ratio	External Bus Clock	S1	S2	S3	JP4 & JP5 & JP6
P150+	120MHz =	2x	60MHz	ON	OFF	OFF	1-2 & 2-3 & 1-2
P166+	133MHz =	2x	66MHz	ON	OFF	OFF	2-3 & 1-2 & 1-2
P200+	150MHz =	2x	75MHz	ON	OFF	OFF	1-2 & 2-3 & 2-3

Cyrix M2	CPU Core Frequency	Ratio	External Bus Clock	S1	S2	S3	JP4 & JP5 & JP6
MX-PR166	150MHz =	2.5x	60MHz	ON	ON	OFF	1-2 & 2-3 & 1-2
MX-PR200	166MHz =	2.5x	66MHz	ON	ON	OFF	2-3 & 1-2 & 1-2
	150MHz =	2x	75MHz	ON	OFF	OFF	1-2 & 2-3 & 2-3
MX-PR233	200MHz =	3x	66MHz	OFF	ON	OFF	2-3 & 1-2 & 1-2
	166MHz =	2x	83.3MHz	ON	OFF	OFF	2-3 & 1-2 & 2-3
MX-PR266	233MHz =	3.5x	66MHz	OFF	OFF	OFF	2-3 & 1-2 & 1-2

AMD K5	CPU Core Frequency	Ratio	External Bus Clock	S1	S2	S3	JP4 & JP5 & JP6
PR90	90MHz =	1.5x	60MHz	OFF	OFF	OFF	1-2 & 2-3 & 1-2

Jumper Table Summary

AMD K5	CPU Core Frequency	Ratio	External Bus Clock	S1	S2	S3	JP4 & JP5 & JP6
PR100	100MHz =	1.5x	66MHz	OFF	OFF	OFF	2-3 & 1-2 & 1-2
PR120	90MHz =	1.5x	60MHz	OFF	OFF	OFF	1-2 & 2-3 & 1-2
PR133	100MHz =	1.5x	66MHz	OFF	OFF	OFF	2-3 & 1-2 & 1-2
PR166	116MHz =	1.75x	66MHz	ON	ON	OFF	2-3 & 1-2 & 1-2

AMD K6	CPU Core Frequency	Ratio	External Bus Clock	S1	S2	S3	JP4 & JP5 & JP6
PR2-166	166MHz =	2.5x	66MHz	ON	ON	OFF	2-3 & 1-2 & 1-2
PR2-200	200MHz =	3x	66MHz	OFF	ON	OFF	2-3 & 1-2 & 1-2
PR2-233	233MHz =	3.5x	66MHz	OFF	OFF	OFF	2-3 & 1-2 & 1-2
PR2-266	266MHz=	4x	66MHz	ON	OFF	ON	2-3 & 1-2 & 1-2
PR2-300	300MHz=	4.5x	66MHz	ON	ON	ON	2-3 & 1-2 & 1-2

IDT C6	CPU Core Frequency	Ratio	External Bus Clock	S1	S2	S3	JP4 & JP5 & JP6
C6-150	150MHz =	2x	75MHz	ON	OFF	OFF	1-2 & 2-3 & 2-3
C6-180	180MHz =	3x	60MHz	OFF	ON	OFF	1-2 & 2-3 & 1-2
C6-200	200MHz =	3x	66MHz	OFF	ON	OFF	2-3 & 1-2 & 1-2

Clear CMOS

<u>JP14</u>	<u>Clear CMOS</u>
1-2	Normal operation (default)
2-3	Clear CMOS