

LONG CREEPAGE TYPE HIGH ISOLATION VOLTAGE 6 PIN OPTOCOUPLER

PS2651
PS2651L2
PS2652
PS2652L2

FEATURES

- **HIGH ISOLATION VOLTAGE**
BV: 5 k Vr.m.s. MIN
- **LONG CREEPAGE AND CLEARANCE DISTANCE**
8 mm MIN
- **HIGH COLLECTOR TO EMITTER VOLTAGE**
 V_{CE0} : 80 V MIN
- **HIGH SPEED SWITCHING**
 $t_r = 3 \mu s$, $t_f = 5 \mu s$ TYP
- **HIGH CURRENT TRANSFER RATIO**
CTR = 200% TYP
- **6 PIN DUAL IN-LINE PACKAGE**

DESCRIPTION

PS2651 and PS2652 are optically coupled isolators containing a GaAs light emitting diode and an NPN silicon phototransistor in a plastic DIP (Dual In-Line Package). PS2651 has a base pin and PS2652 has no base pin. Creepage distance and clearance of leads are over 8 millimeters. PS2651L2 and PS2652L2 are lead bending type (Gull-wing) for surface mounting.

APPLICATIONS

Interface circuit for various instrumentations and control equipment.

- AC LINE/DIGITAL LOGIC
- DIGITAL LOGIC INTERFACE
- TWISTED PAIR LINE RECEIVER
- TELEPHONE/TELEGRAPH LINE RECEIVER
- HIGH FREQUENCY POWER SUPPLY FEEDBACK CONTROL
- RELAY CONTACT MONITOR
- POWER SUPPLY MONITOR

ELECTRICAL CHARACTERISTICS ($T_A = 25^\circ C$)

PART NUMBER			PS2651, PS2651L2, PS2652, PS2652L2			
SYMBOLS	PARAMETERS	UNITS	MIN	TYP	MAX	
Diode	V_F	Forward Voltage, $I_F = 10 \text{ mA}$	V	1.1	1.4	
	I_R	Reverse Current, $V_R = 5 \text{ V}$	μA		5	
	C	Junction Capacitance, $V = 0$, $f = 1.0 \text{ MHz}$	pF	30		
Transistor	I_{CE0}	Collector to Emitter Dark Current, $V_{CE} = 80 \text{ V}$, $I_F = 0$	nA		100	
	BV_{CEO}	Collector to Emitter Breakdown Voltage, $I_C = 1 \text{ mA}$, $I_B = 0$	V	80		
	BV_{ECO}	Emitter to Collector Breakdown Voltage, $I_E = 100 \mu A$, $I_B = 0$	V	7		
Coupled	CTR	Current Transfer Ratio ¹ , $I_F = 5 \text{ mA}$, $V_{CE} = 5 \text{ V}$	%	50	200	400
	$V_{CE(sat)}$	Collector Saturation Voltage, $I_F = 10 \text{ mA}$, $I_C = 2 \text{ mA}$	V			0.3
	R1-2	Isolation Resistance, $V_{in-out} = 1.0 \text{ k V}$	Ω	10^{11}		
	C1-2	Isolation Capacitance, $V = 0$, $f = 1.0 \text{ MHz}$	pF		0.6	
	t_r	Rise Time ² , $V_{CC} = 5 \text{ V}$, $I_C = 2 \text{ mA}$	μs		3	
t_f	Fall Time ² , $V_{CC} = 5 \text{ V}$, $I_C = 2 \text{ mA}$	μs		5		

1. CTR rank

KD : 160 to 400 (%)
LD : 80 to 240 (%)
MD : 50 to 120 (%)

2. Test Circuit for Switching Time

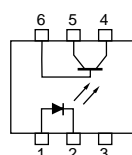

PS2651

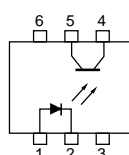

PS2652

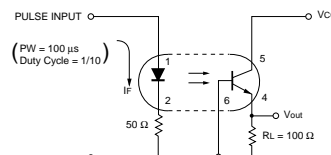

PS2651

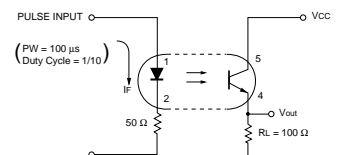

PS2652

ABSOLUTE MAXIMUM RATINGS¹ (T_A = 25°C)

SYMBOLS	PARAMETERS	UNITS	RATINGS
Diode			
V _R	Reverse Voltage	V	6
I _F	Forward Current	mA	80
P _D	Power Dissipation	mW	150
I _{F (Peak)}	Peak Forward Current PW = 100 μs, Duty Cycle 1%	A	1
Transistor			
V _{CEO}	Collector to Emitter Voltage	V	80
V _{ECO}	Emitter to Collector Voltage	V	7
I _C	Collector Current	mA	50
P _C	Power Dissipation	mW	150
Coupled			
BV	Isolation Voltage ²	V _{r.m.s.}	5000
T _{STG}	Storage Temperature	°C	-55 to +150
T _{OP}	Operating Temperature	°C	-55 to +100

Notes:

1. Operation in excess of any one of these parameters may result in permanent damage.
2. AC voltage for 1 minute at T_A = 25 °C, RH = 60 % between input (Pin No. 1, 2, 3 Common) and output (Pin No. 4, 5, 6 Common).

TYPICAL PERFORMANCE CURVES (T_A = 25 °C)

DIODE POWER DISSIPATION vs. AMBIENT TEMPERATURE

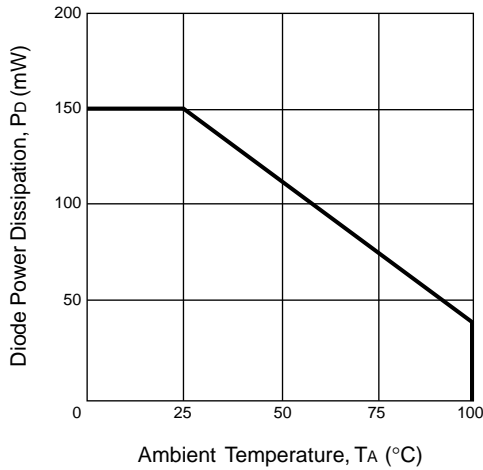

TRANSISTOR POWER DISSIPATION vs. AMBIENT TEMPERATURE

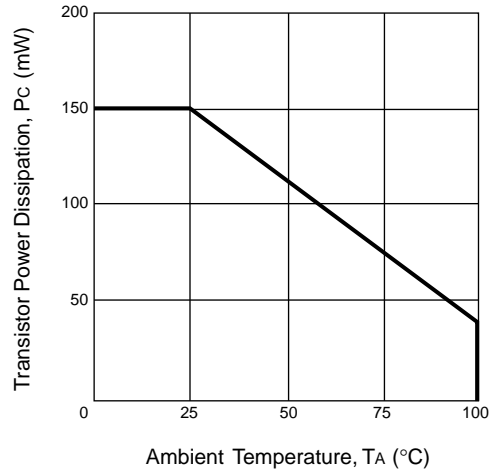

FORWARD CURRENT vs. FORWARD VOLTAGE

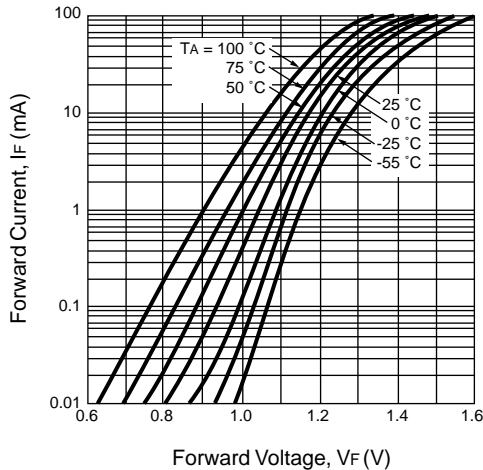

COLLECTOR CURRENT vs. COLLECTOR TO EMITTER VOLTAGE

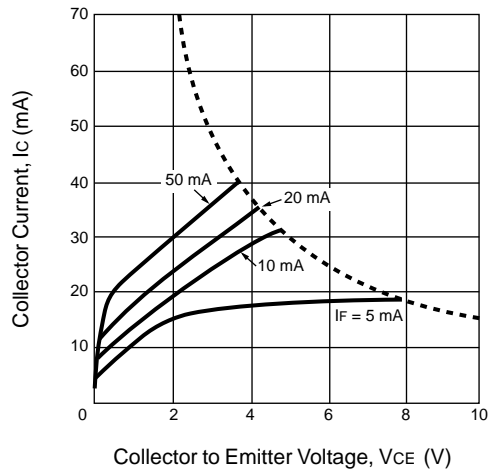

TYPICAL PERFORMANCE CURVES ($T_A = 25\text{ }^\circ\text{C}$)

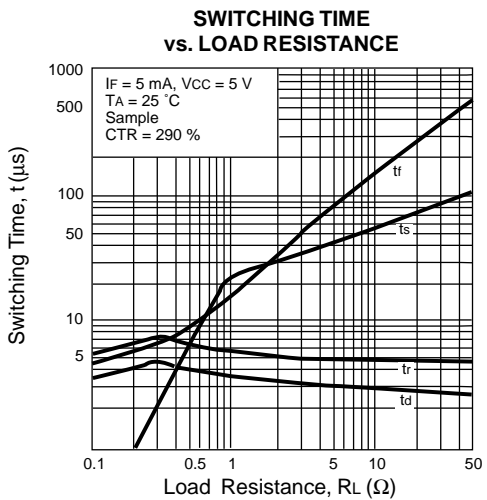
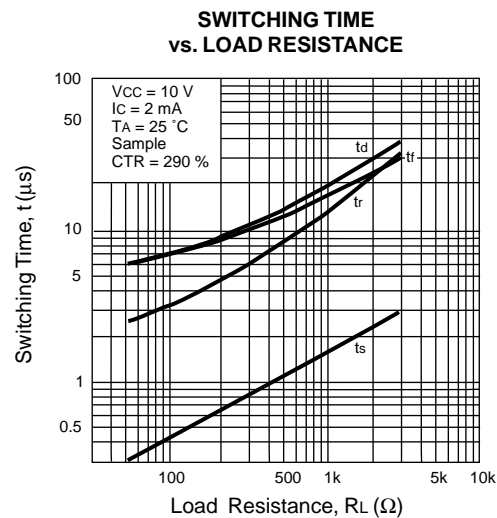
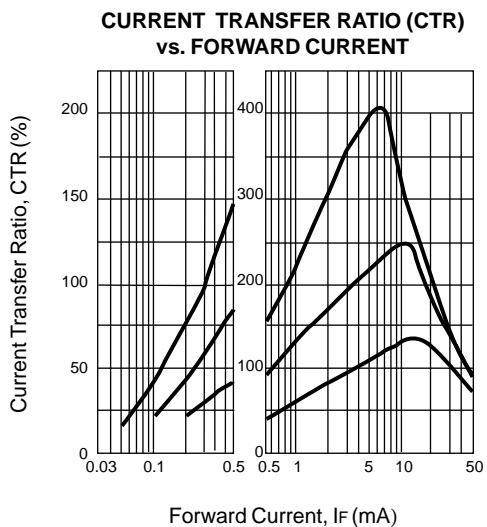
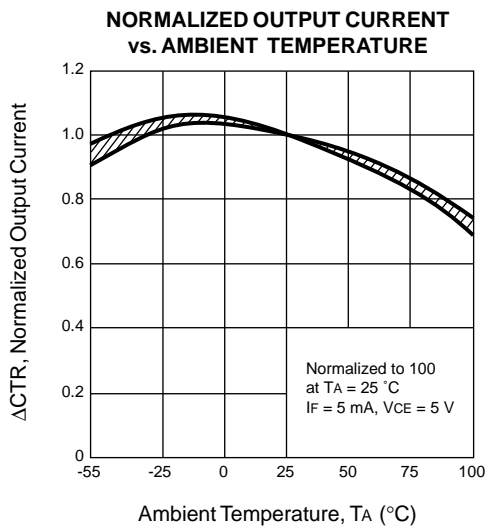
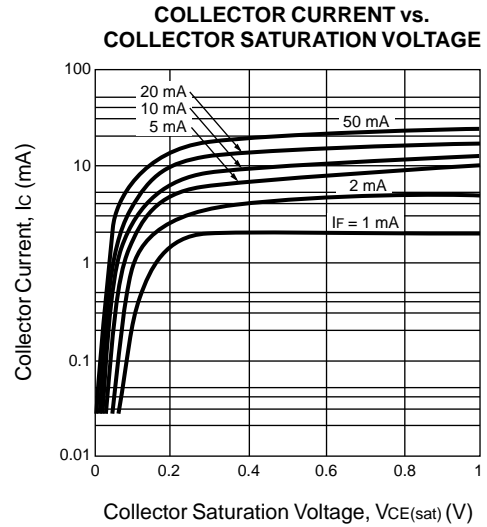
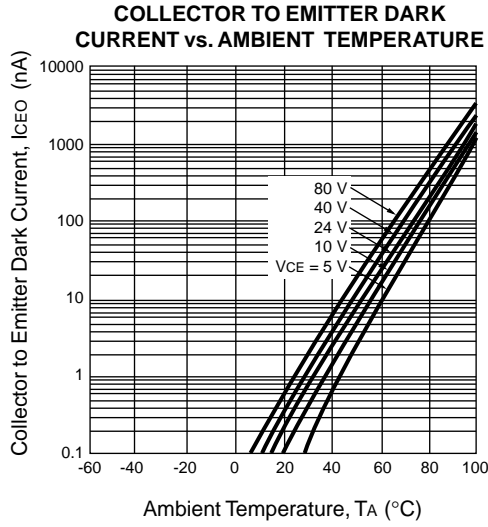

TYPICAL PERFORMANCE CURVES (TA = 25 °C)

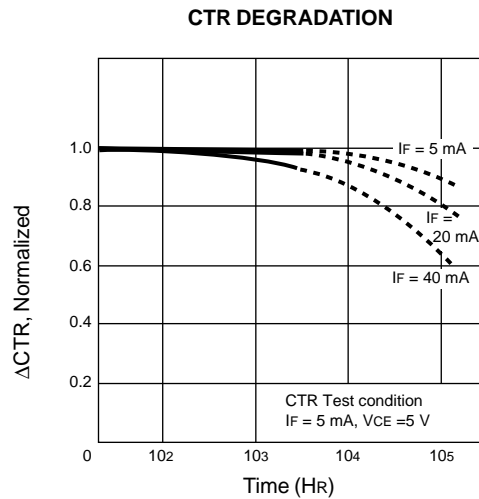
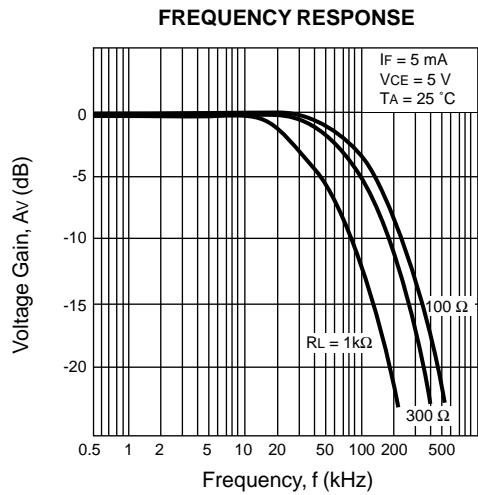

OUTLINE DIMENSIONS (Units in mm)

PS2651, PS2652

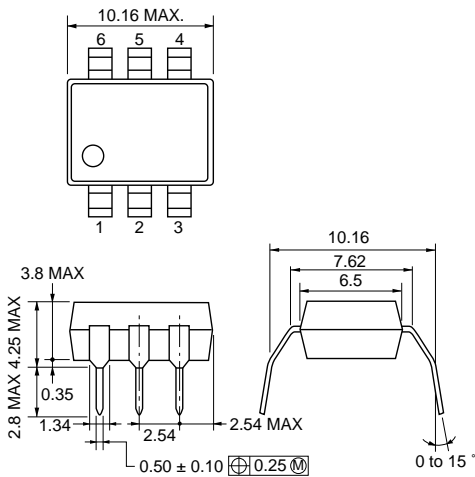

PS2651L2, PS2652L2

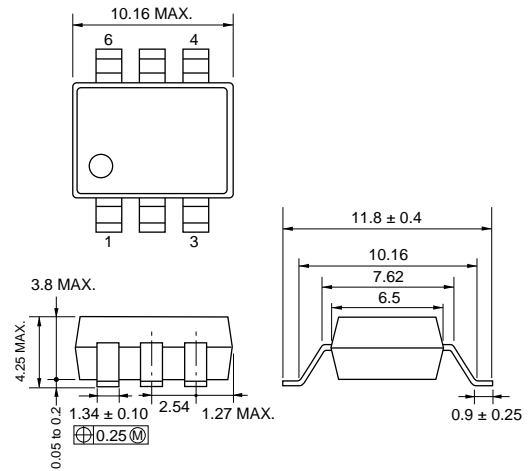

PIN CONNECTION (Top View)

PS2651, PS2651L2

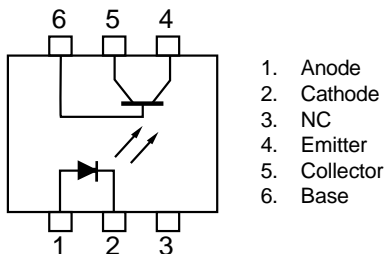

PS2652, PS2652L2

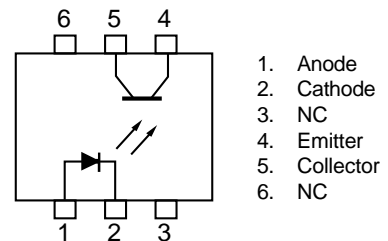

EXCLUSIVE NORTH AMERICAN AGENT FOR **NEC** RF, MICROWAVE & OPTOELECTRONIC SEMICONDUCTORS

CEL CALIFORNIA EASTERN LABORATORIES • Headquarters • 4590 Patrick Henry Drive • Santa Clara, CA 95054-1817 • (408) 988-3500 • Telex 34-6393 • FAX (408) 988-0279
24-Hour Fax-On-Demand: 800-390-3232 (U.S. and Canada only) • Internet: <http://WWW.CEL.COM>

DATA SUBJECT TO CHANGE WITHOUT NOTICE

PRINTED IN USA ON RECYCLED PAPER -3/98