

**LA4525**

Dual AF Power Amplifier for Radio Cassette Recorders

Overview

The LA4525 requires only a small number of external components to drive either two 4 Ω speakers or one 8 Ω speaker. The output power is typically 0.65 W when driving two 4 Ω speakers.

Features

- Two-channel (dual) or single-channel (BTL) operation
- Requires only a few external components.
- 0.65 W (typ) output power into two 4 Ω speakers
- Wide power supply range: 3 to 15 V
- 8-pin DIP (No heat sink needed)

Package Dimensions

unit : mm

3001B-DIP8

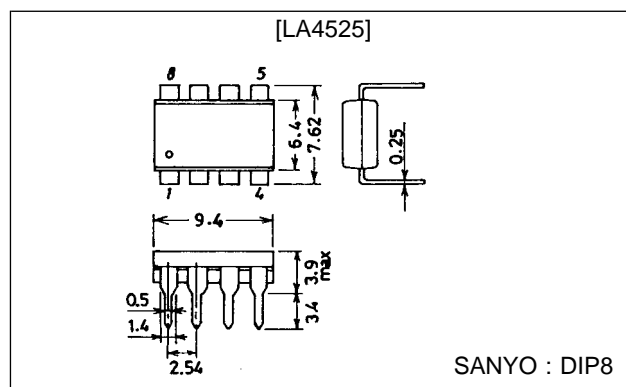

Specifications

Absolute Maximum Ratings at $T_a = 25^\circ\text{C}$

Parameter	Symbol	Conditions	Ratings	Unit
Maximum supply voltage	$V_{CC \text{ max}}$	$R_g = 0$	15	V
Allowable power dissipation	$P_d \text{ max}$	Note	1.5	W
Operating temperature	T_{op}		-25 to +75	$^\circ\text{C}$
Storage temperature	T_{stg}		-40 to +150	$^\circ\text{C}$

Note: Mounted on a $50 \times 50 \times 1.6 \text{ mm}^3$ heat dissipating board

Recommended Operating Conditions at $T_a = 25^\circ\text{C}$

Parameter	Symbol	Conditions	Ratings	Unit
Supply voltage	V_{CC}		6	V
Load resistance range	R_L		4	Ω
Supply voltage range	$V_{CC \text{ op}}$	Not in excess of package P_d	3 to 15	V

LA4525

**Operating Characteristics at $V_{CC} = 6\text{ V}$, $T_a = 25^\circ\text{C}$, $R_L = 4\ \Omega$, $f = 1\text{ kHz}$, $R_g = 600\ \Omega$,
Dual operation unless otherwise noted**

Parameter	Symbol	Condition	min	typ	max	Unit
Quiescent supply current	I_{CCO}	$R_g = 0\ \Omega$	10	15	30	mA
Output power	P_{O1}	THD = 10%	0.45	0.65		W
	P_{O2}	$V_{CC} = 9\text{ V}$, $R_L = 8\ \Omega$, THD = 10%		1.0		W
Voltage gain	VG	$V_O = 0\text{ dBm}$	38	40	42	dB
Total harmonic distortion	THD	$P_O = 0.1\text{ W}$		0.2	0.7	%
Output noise voltage	V_{NO}	$R_g = 0\ \Omega$, DIN AUDIO filter		100	400	μV
Supply voltage ripple rejection	SVRR	$R_g = 0\ \Omega$, $f_R = 100\text{ Hz}$, $V_R = 0\text{ dBm}$	35	43		dB
Channel separation	CH Sep	$V_O = 0\text{ dBm}$, $R_g = 0\ \Omega$	45	55		dB
Input resistance	R_i		70	100	130	$\text{k}\Omega$

Equivalent Block Diagram

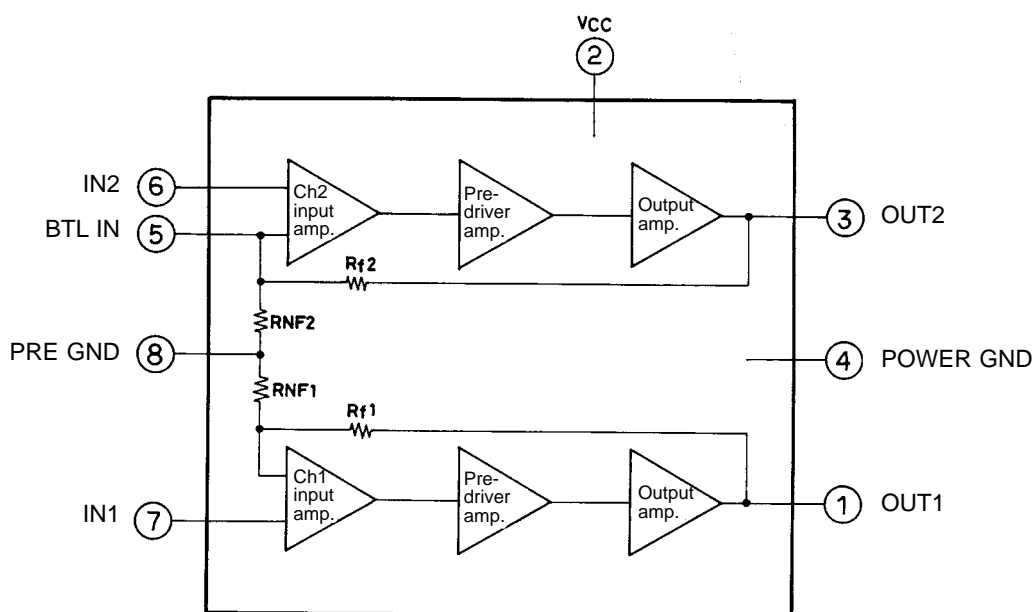

Pin Description

Number	Name	Description
1	OUT1	Channel 1 output
2	V_{CC}	Supply voltage
3	OUT2	Channel 2 output
4	POWER GND	Power amplifier ground
5	BTL IN	Bridge test load input
6	IN2	Channel 2 input
7	IN1	Channel 1 input
8	PRE GND	Preamplifier ground

LA4525

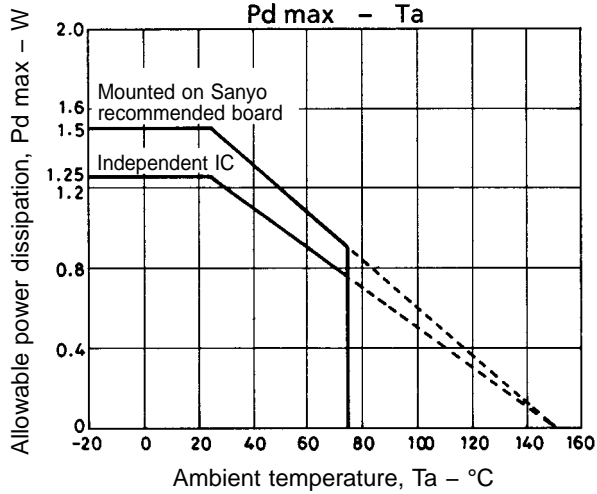

Dual Operation

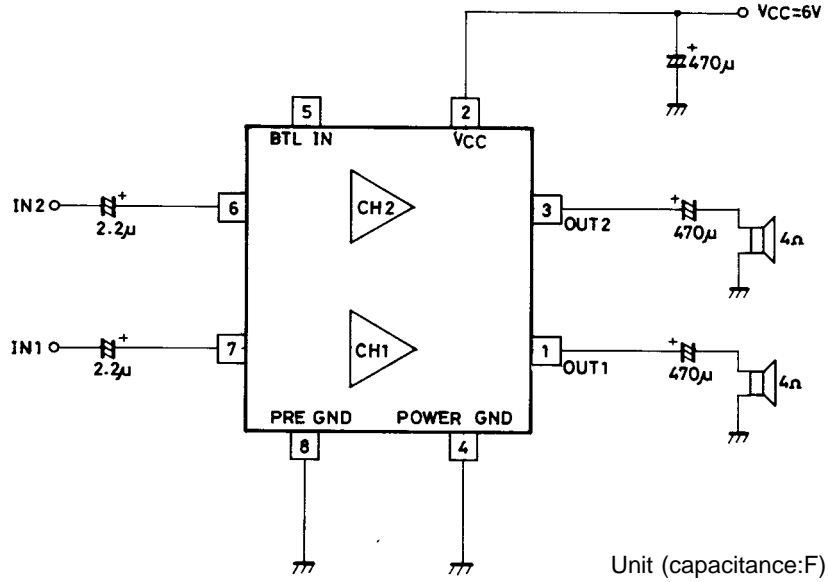

Sample Printed Circuit Pattern

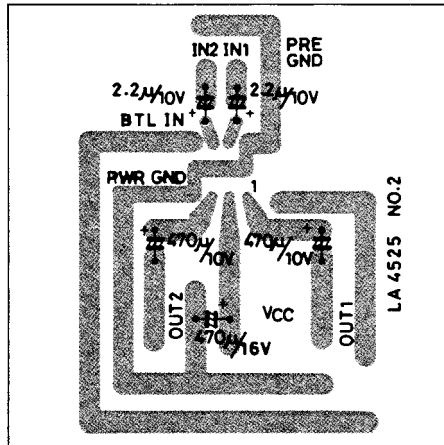

External Components Comparison

External components	Existing Sanyo ICs	LA4525
Output capacitors	○	○
Input capacitors	○	○
Bootstrap capacitors	○	×
Feedback capacitors	○	×
Filter capacitors	○	×
Oscillation damping mylars	○	×
Dual-mode operation total	11	4

Pin Voltages

Pin number	Pin name	Pin voltage
1	OUT1	2.8 V
2	V _{CC}	6 V
3	OUT2	2.8 V
4	POWER GND	0 V
5	BTL IN	65 mV
6	IN2	1.4 V
7	IN1	1.4 V
8	PRE GND	0 V

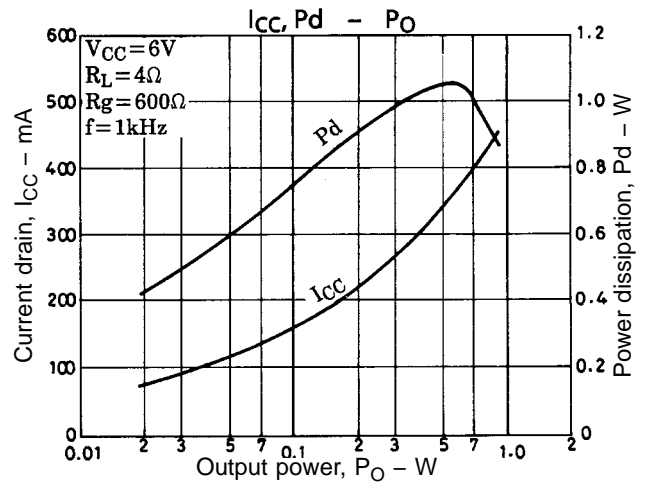
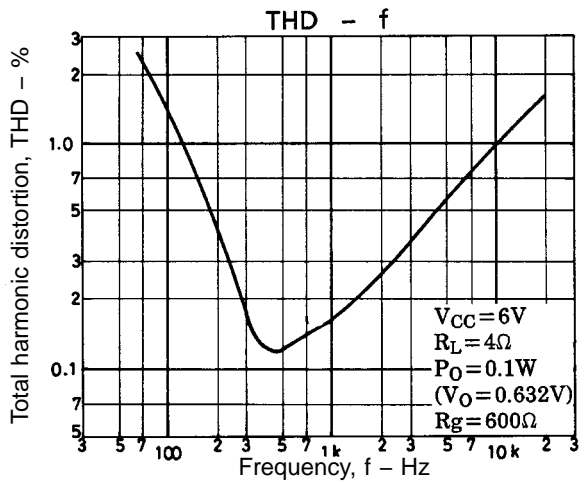
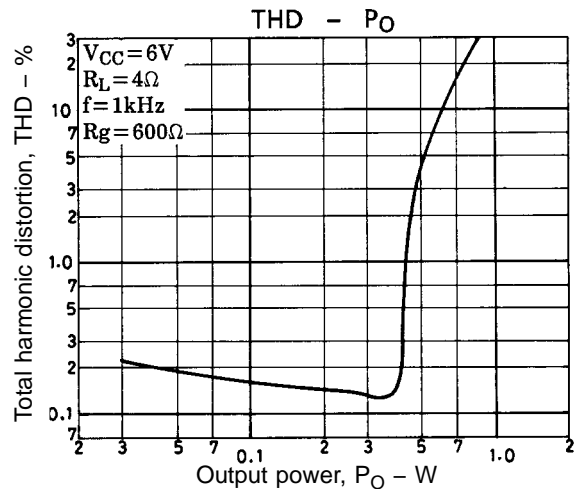
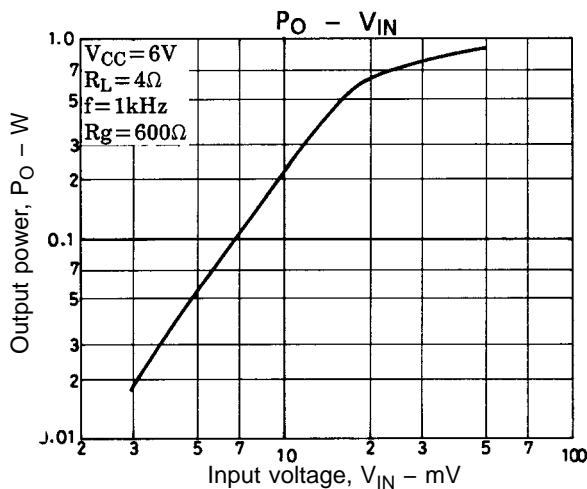
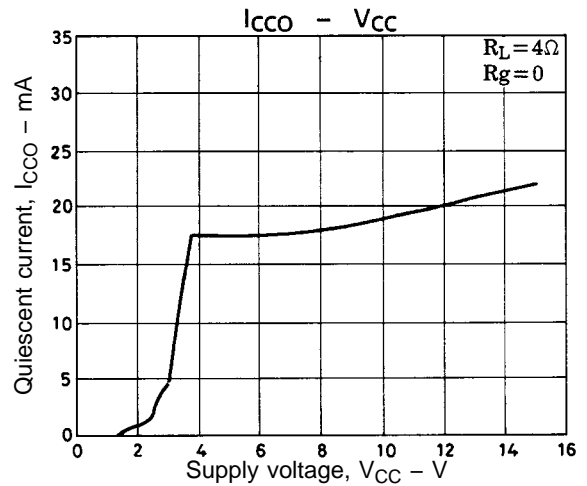
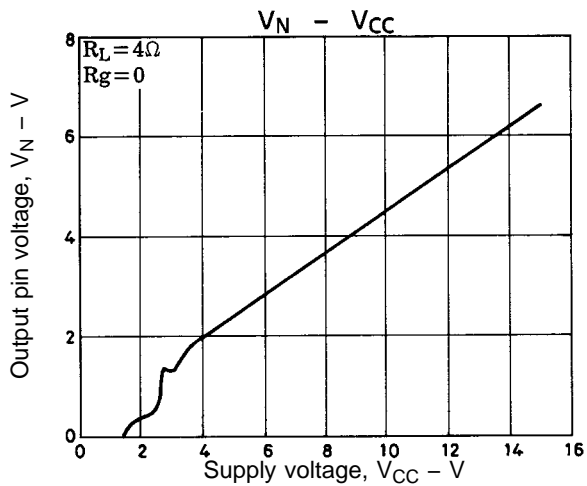

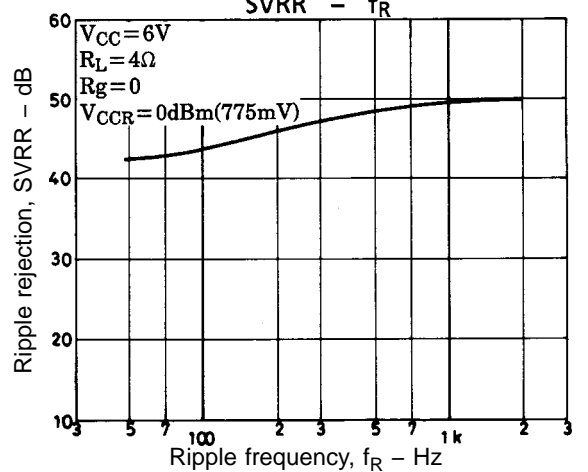
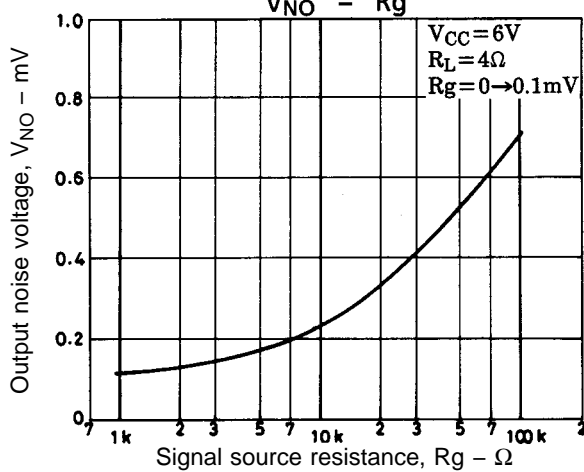
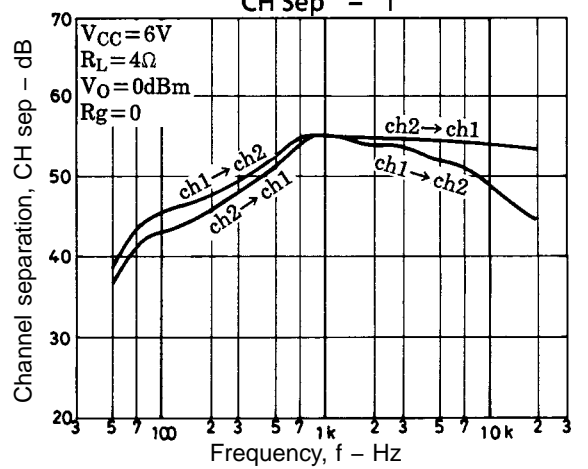
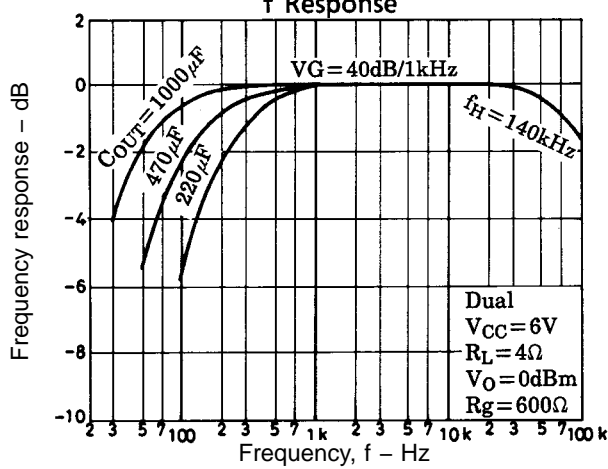
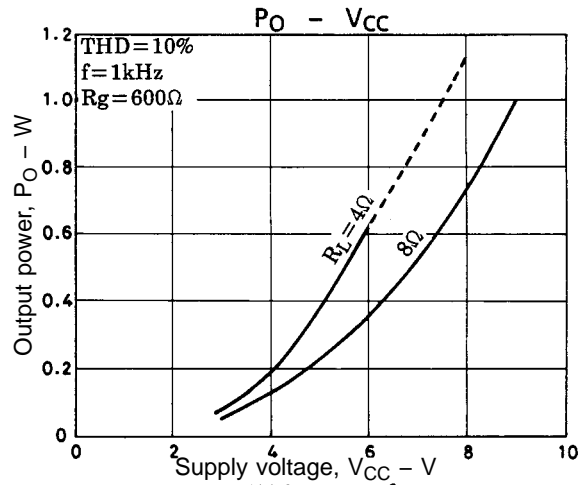
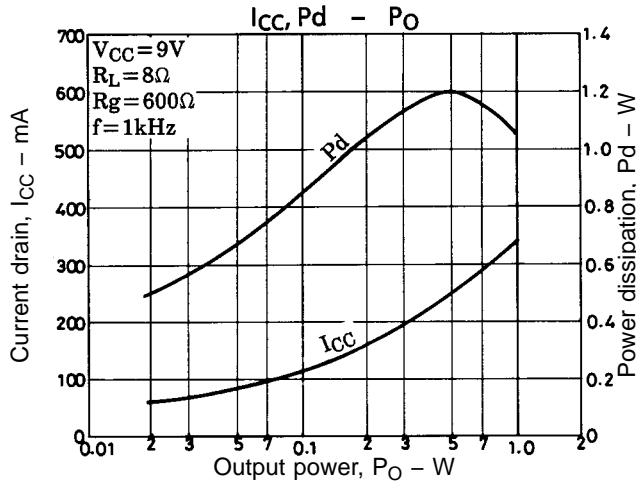

Rising and falling waveforms

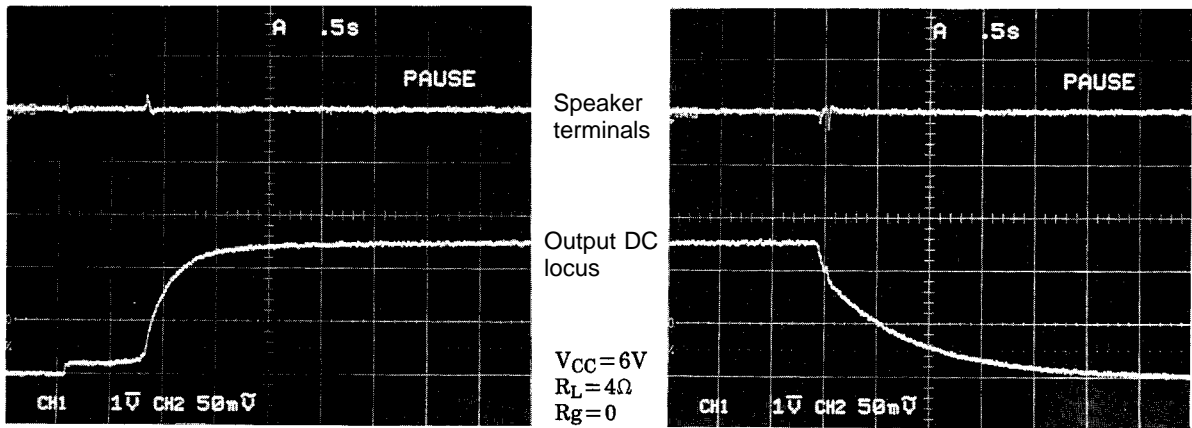

BTL Operation

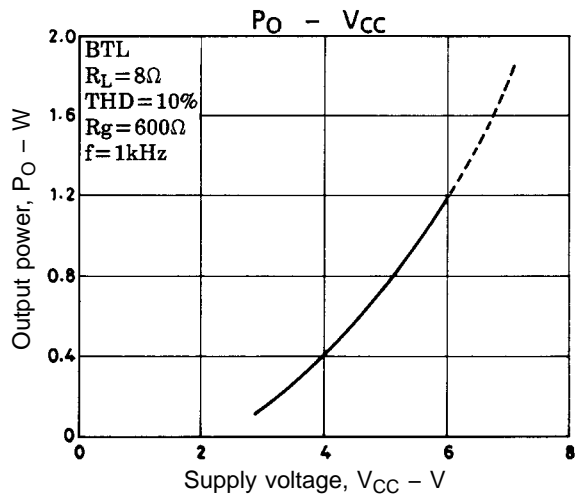
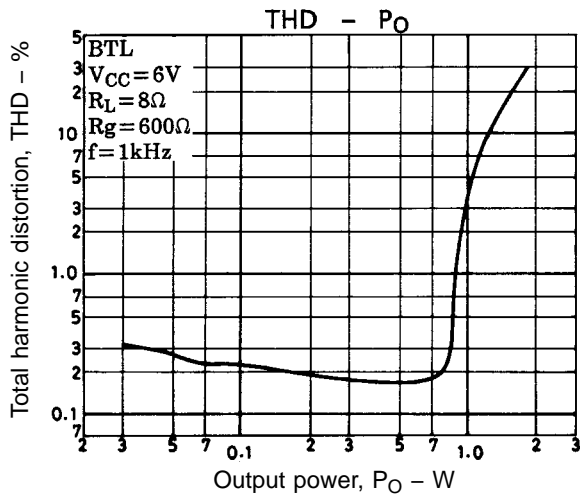
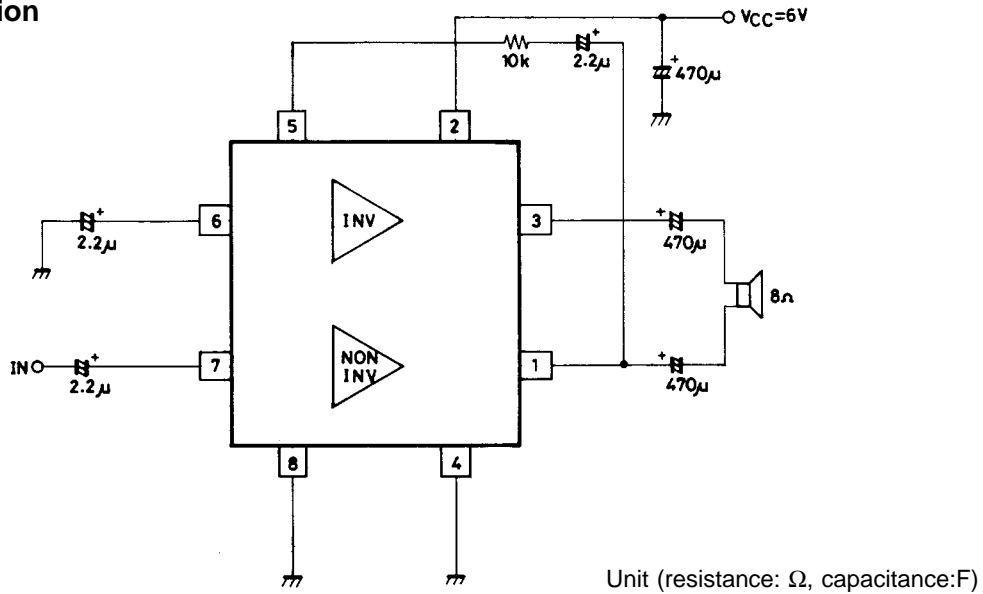

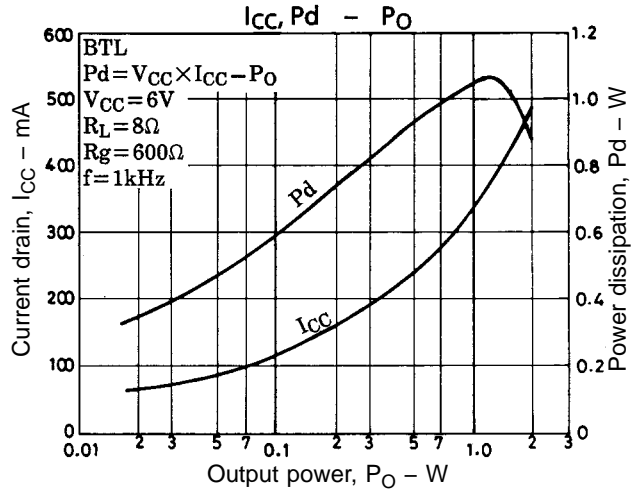
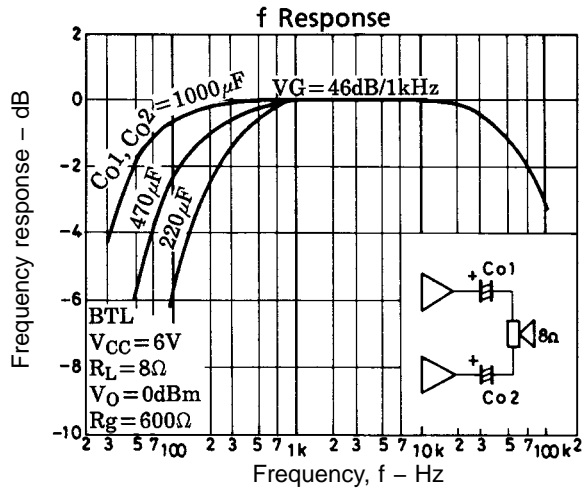

Handling Instructions and Precautions

Internal Circuits

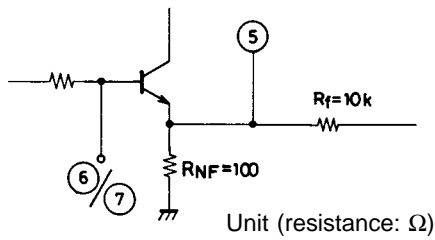

Figure 1. Input pins (6 and 7) and BTL input pin (5)

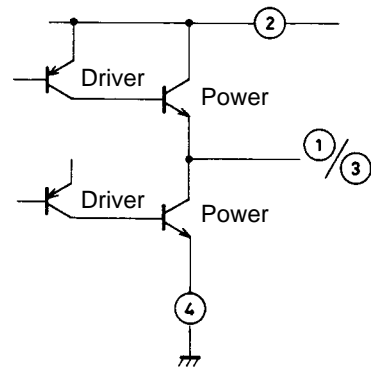
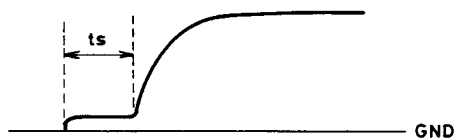

Figure 2. Output pins (1 and 3)

External Components

- The starting time, t_s , can be varied by changing the value of the input capacitor. A value of 2.2 μF is recommended. A smaller value will result in a lower starting time, and a larger value, a higher starting time.



- The output capacitor should have a value of 470 μF . A lower value will cause the low-frequency roll-off and low-power characteristics to deteriorate.
- A value of 470 μF is recommended for the power supply capacitor, although this can change according to the design setup conditions.
- In dual mode, BTL IN (the channel 2 negative feedback connection) should be left floating.

BTL mode

- The output capacitors should have a value of 470 μF . If these are omitted, a “popping” noise occurs. Also, any output offset will cause a current to flow which could damage the load under quiescent DC conditions.

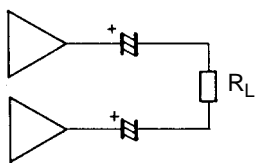

- The output capacitors can be replaced with a single 220 μF bipolar capacitor. A larger value can cause switching noise when power is applied to the device.
- The voltage gain is fixed internally to 40 dB in dual mode and 46 dB in BTL mode. These values cannot be altered by connecting external components.
- Phase correction capacitance (600 pF/TOTAL) is incorporated in the internal stages. Oscillation damping components (R and C) are also incorporated in the output pin circuits.
- Power consumption
Note that the 8-pin DIP does not have a heat dissipating surface and that the power dissipation ratings are critical. The maximum power dissipation of the device is 1.25 W, and 1.5 W when the device is mounted on the recommended PCB. The actual power dissipated depends on the supply voltage and the load conditions. Ensure that the device is kept within its maximum rating. For AC supplies, transformer tapings may need to be adjusted to keep the device within maximum ratings.

$$P_{d \max} = \frac{V_{CC}^2}{\pi^2 R_L} + I_{CCO} \times V_{CC}$$

Note

For BTL mode operation, the value of R_L used in the calculation should be 1/2 the actual value.

- If the speaker plug jacks short to ground when connected, a protection resistor should be inserted in the output line.
- If the device is operated at or near its rated values, these values can be exceeded by small changes in operating conditions, leading to device breakdown. Accordingly, ensure that a safety margin is maintained so as not to exceed the maximum ratings.
- Check the PCB surface after soldering to ensure that no pins have been accidentally shorted. Any short between pins could cause poor operating characteristics or permanently damage the device when power is applied.
- If making the PCB, check the printed wiring to ensure that no feedback loops occur between input and output.

- No products described or contained herein are intended for use in surgical implants, life-support systems, aerospace equipment, nuclear power control systems, vehicles, disaster/crime-prevention equipment and the like, the failure of which may directly or indirectly cause injury, death or property loss.
- Anyone purchasing any products described or contained herein for an above-mentioned use shall:
 - ① Accept full responsibility and indemnify and defend SANYO ELECTRIC CO., LTD., its affiliates, subsidiaries and distributors and all their officers and employees, jointly and severally, against any and all claims and litigation and all damages, cost and expenses associated with such use:
 - ② Not impose any responsibility for any fault or negligence which may be cited in any such claim or litigation on SANYO ELECTRIC CO., LTD., its affiliates, subsidiaries and distributors or any of their officers and employees jointly or severally.
- Information (including circuit diagrams and circuit parameters) herein is for example only; it is not guaranteed for volume production. SANYO believes information herein is accurate and reliable, but no guarantees are made or implied regarding its use or any infringements of intellectual property rights or other rights of third parties.