

FEATURES

- Low operating power dissipation < 10mW
- Low quiescent power dissipation < 5mW
- Counts and displays 7 decades
- Wide operating supply voltage range
 $2V \leq V^+ \leq 6V$
- Drives directly 7 decade multiplexed common cathode LED display
- Internal store capability
- Internal inhibit to counter input
- Test speedup point
- All terminals protected against static discharge

DESCRIPTION

The ICM7208 is a fully integrated seven decade counter-decoder-driver and is manufactured using Intersil's low voltage metal gate C-MOS process.

Specifically the ICM7208 provides the following on chip functions: a 7 decade counter, multiplexer, 7 segment decoder, digit & segment driver, plus additional logic for display blanking, reset, input inhibit, and display on/off.

For unit counter applications the only additional components are a 7 digit common cathode display, 3 resistors and a capacitor to generate the multiplex frequency reference, and the control switches.

The ICM7208 is intended to operate over a supply voltage of 2 to 6 volts as a medium speed counter, or over a more restricted voltage range for high frequency applications.

As a frequency counter it is recommended that the ICM7208 be used in conjunction with the ICM7207 Oscillator Controller, which provides a stable HF oscillator, and output signal gating.

ORDERING INFORMATION

ORDER PART NUMBER	TEMPERATURE RANGE	28 LEAD PACKAGE
ICM7208IPI	-20°C to +70°C	PLASTIC
ORDER DICE BY FOLLOWING PART NUMBER: ICM7208D		

CONNECTION DIAGRAM

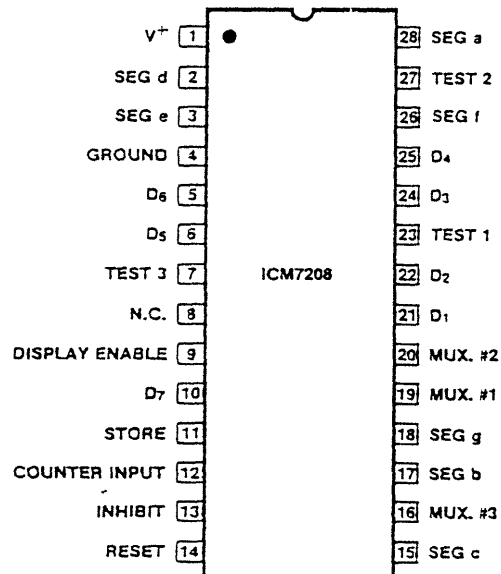

ICM7208 CMOS 7 Decade Counter

Low Power CMOS

ABSOLUTE MAXIMUM RATINGS

Power Dissipation (Note 1)	1 W
Supply voltage (Note 2)	6V
Output digit drive current (Note 3)	150mA
Output segment drive current	30 mA
Input voltage range (any input terminal)	Not to exceed the supply voltage
Operating temperature range	-20°C to +70°C
Storage temperature range	-55°C to +125°C

Stresses above those listed under Absolute Maximum Ratings may cause permanent damage to the device. These are stress ratings only, a functional operation of the device at these or any other conditions above those indicated in the operational sections of the specifications is implied. Exposure to absolute maximum rating conditions for extended periods may affect device reliability.

TYPICAL OPERATION CHARACTERISTICS

TEST CONDITIONS: ($V^+ = 5V$, $T_A = 5^\circ C$, TEST CIRCUIT, display off, unless otherwise specified)

PARAMETER	SYMBOL	CONDITIONS	MIN	TYP	MAX	UNITS
Quiescent Current	I_Q	All controls plus terminal 19 connected to V^+ No multiplex oscillator		30	100	μA
Quiescent Current	I_Q	All control inputs plus terminal 19 connected to V^+ except store which is connected to GROUND		70	150	
Operating Supply Current	I^+	All inputs connected to V^+ , RC multiplexer osc operating $f_{in} < 25KHz$		210	500	
Operating Supply Current	I^+	$f_{in} = 2MHz$			700	
Supply Voltage Range	V^+	$f_{in} \leq 2MHz$	3.5		5.5	V
Digit Driver On Resistance	r_{DIG}			4	12	Ω
Digit Driver Leakage Current	I_{DIG}				500	μA
Segment Driver On Resistance	r_{SEG}			40		Ω
Segment Driver Leakage Current	I_{SLK}				500	μA
Pullup Resistance of Reset or Store Inputs	R_p		100	400		k Ω
Counter Input Resistance	R_{IN}	Terminal 12 either at V^+ or GROUND			100	
Counter Input Hysteresis Voltage	V_{HIN}			25	50	mV

NOTE 1: This value of power dissipation refers to that of the package and will not be obtained under normal operating conditions.

NOTE 2: The supply voltage must be applied before or at the same time as any input voltage. This poses no problems with a single power supply system. If a multiple power supply system is used, it is mandatory that the supply for the ICM7208 is switched on before the other supplies otherwise the device may be permanently damaged.

NOTE 3: The output digit drive current must be limited to 150mA or less under steady state conditions. (Short term transients up to 250mA will not damage the device.) Therefore, depending upon the LED display and the supply voltage to be used it may be necessary to include additional segment series resistors to limit the digit currents.

TYPICAL PERFORMANCE CHARACTERISTICS

MAXIMUM COUNTER INPUT FREQUENCY AS A FUNCTION OF SUPPLY VOLTAGE

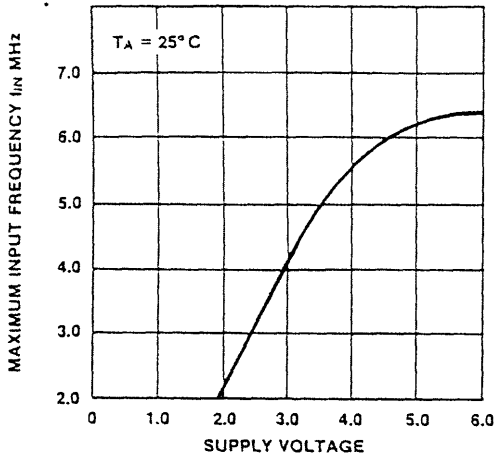

SEGMENT OUTPUT CURRENT AS A FUNCTION OF SUPPLY VOLTAGE

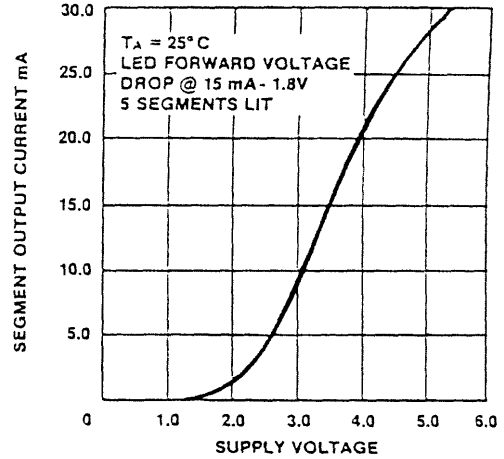

SUPPLY CURRENT AS A FUNCTION OF SUPPLY VOLTAGE

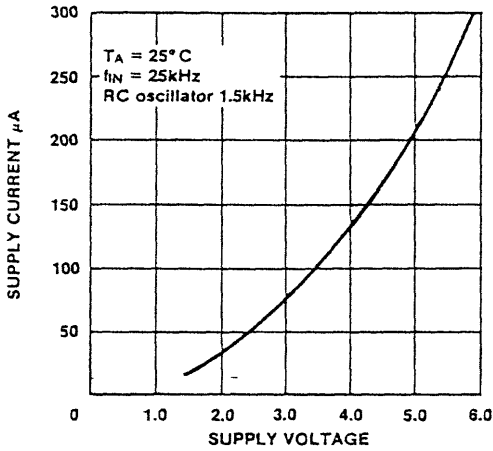

SUPPLY CURRENT AS A FUNCTION OF COUNTER INPUT FREQUENCY

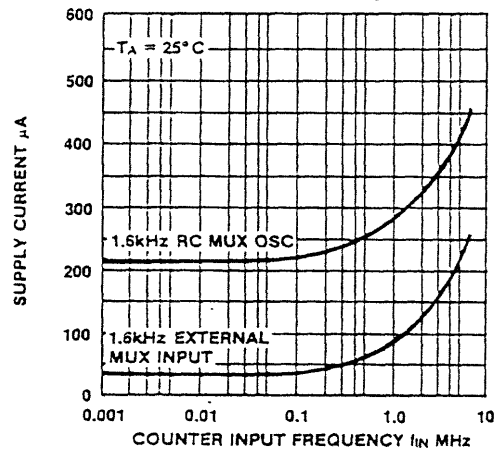

TEST CIRCUIT

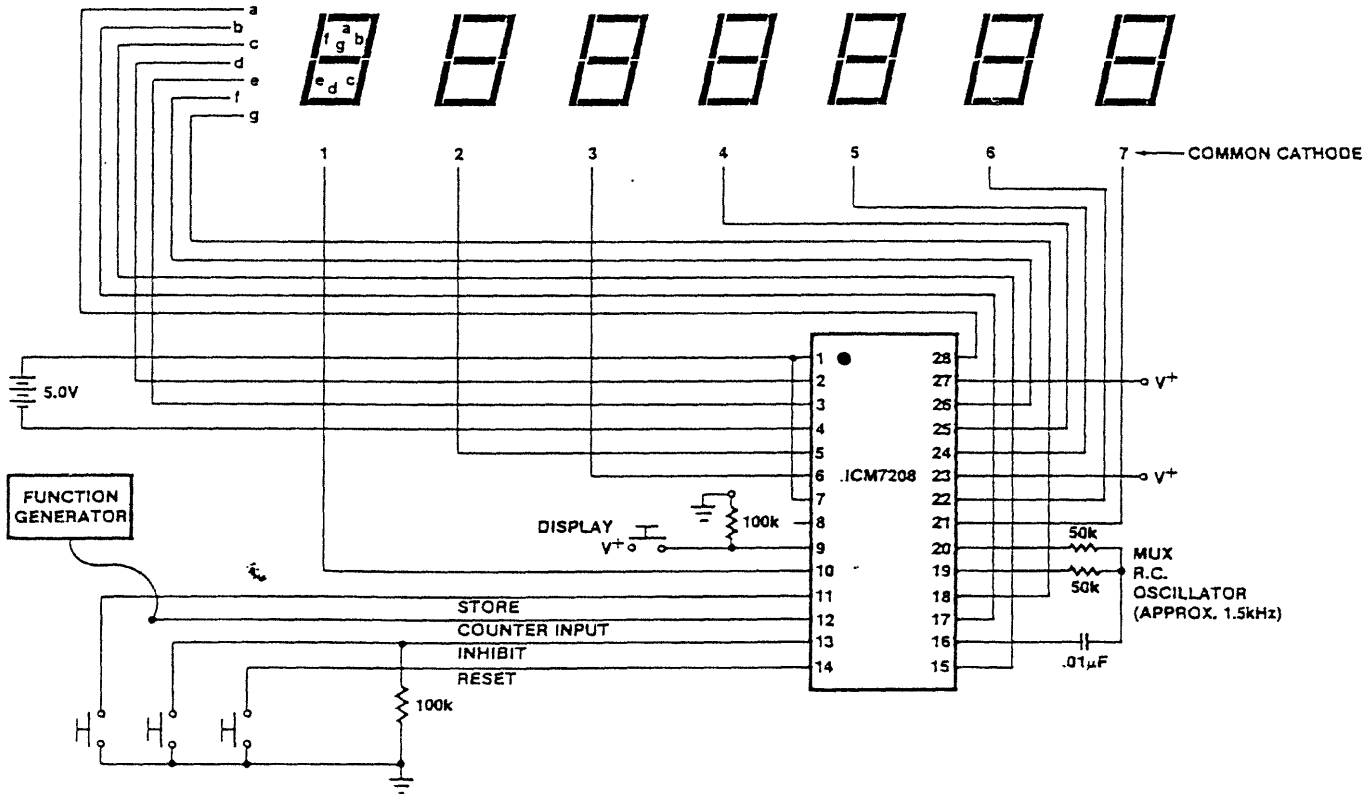

TEST PROCEDURES

The ICM7208 is provided with three input terminals 7, 23, 27 which may be used to accelerate testing. The least two significant decade counters may be tested by applying an input to the 'COUNTER INPUT' terminal 12. 'TEST POINT' terminal 23 provides an input which bypasses the 2 least significant decade counters and permits an injection of a signal into the third decade counter. Similarly terminals 7 and 27 permit rapid counter advancing at two points further along the string of decade counters.

CONTROL INPUT DEFINITIONS

INPUT	TERMINAL	VOLTAGE	FUNCTION
1. Display	9	V ⁺ Ground	Display On Display Off
2. Store	11	V ⁺ Ground	Counter Information Stored Counter Information Transferring
3. Inhibit	13	V ⁺ Ground	Input to Counter Blocked Normal Operator
4. Reset	14	V ⁺ Ground	Normal Operator Counters Reset

COUNTER INPUT DEFINITION

The internal counters of the ICM7208 index on the negative edge of the input signal at terminal #12.

BLOCK DIAGRAM

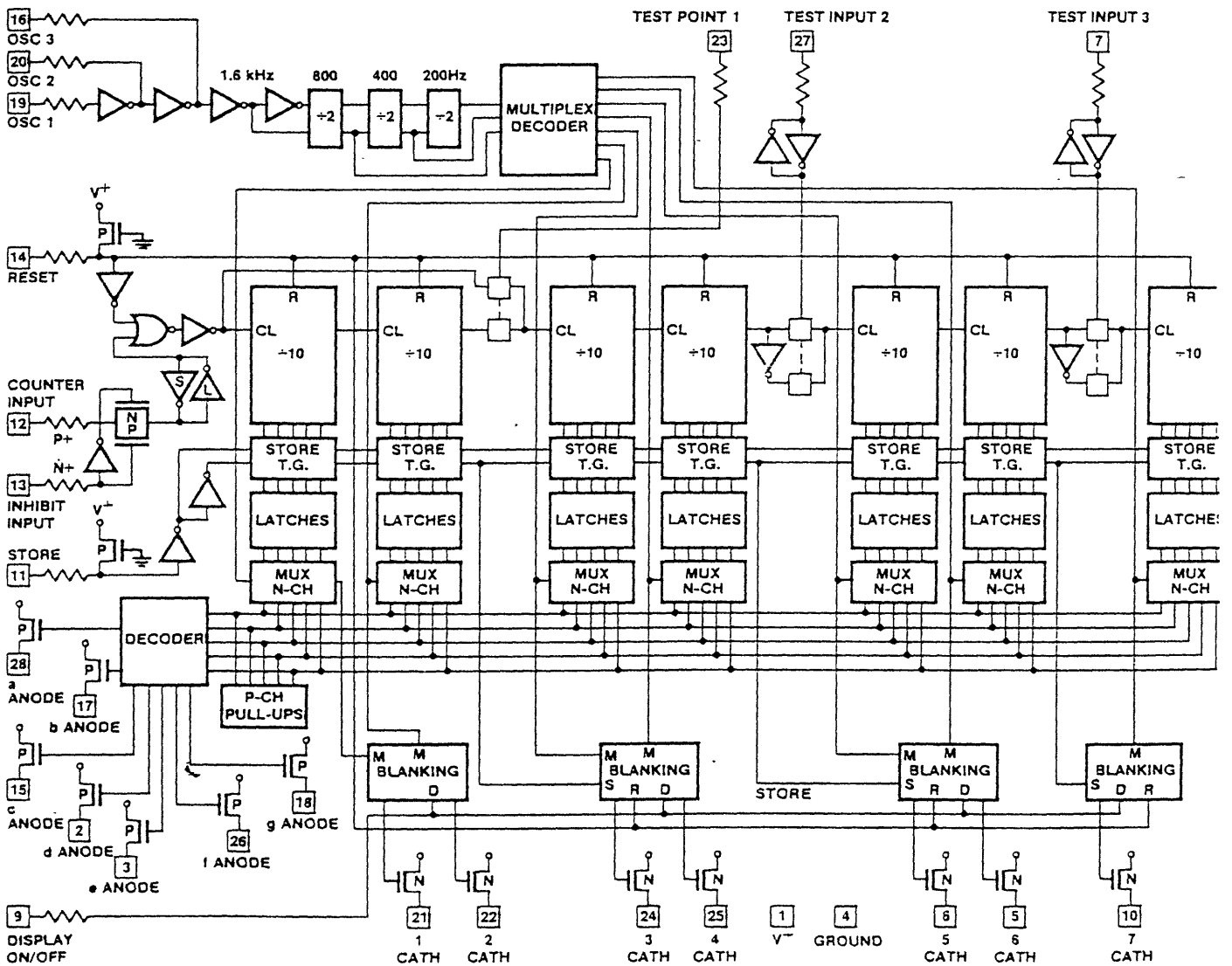

5. Frequency Counter

The ICM7208 may be used as a frequency counter when used with an external frequency reference and gating logic. This can be achieved using the ICM7207 Oscillator Controller (Figure 2). The ICM7207 uses a crystal controlled oscillator to provide the store and reset pulses together with the counting window. Figure 3 shows the recommended input gating waveforms to the ICM7208. At the end of a counting period (50% duty cycle) the counter input is inhibited. The counter information is then transferred and stored in latches, and can be displayed. Immediately after

this information is stored, the counters are cleared and are ready to start a new count when the counter input is enabled. Using a 6.5536MHz quartz crystal and the ICM7207 driving the ICM7208, two ranges of counting may be obtained, using either 0.01 sec or 0.1 sec counter enable windows.

Previous comments on leading zero blanking, etc., apply as per the unit counter.

The ICM7207 provides the multiplex frequency reference at 1.6kHz.

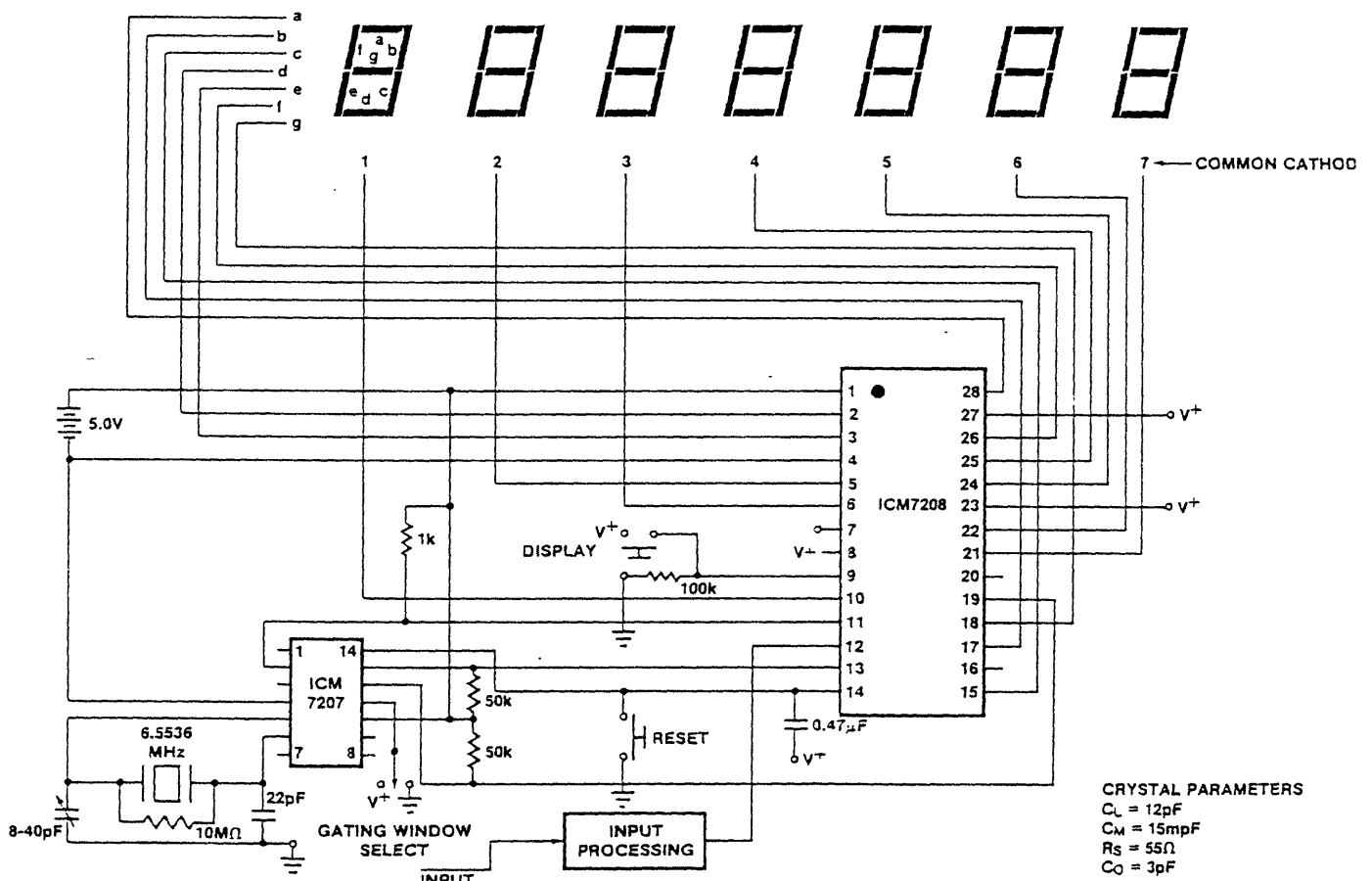

Figure 2: Frequency Counter

Note: For a 1 sec count window which allows all 7 digits to be used with a resolution of 1Hz, the ICM7207 can be replaced with the ICM7207A. Circuit details are given on the 7207A data sheet.

APPLICATION NOTES

GENERAL

1. Format of Signal to be Counted

The noise immunity of the Signal Input Terminal is approximately 1/3 the supply voltage. Consequently, the input signal should be at least 50% of the supply in peak to peak amplitude and preferably equal to the supply. **NOTE: The amplitude of the input signal should not exceed the supply; otherwise, damage may be done to the circuit.**

The optimum input signal is a 50% duty cycle square wave equal in amplitude to the supply. However, as long as the rate of change of voltage is not less than approximately 10-4V/ μ sec at 50% of the power supply voltage, the input waveshape can be sinusoidal, triangular, etc.

When driving the input of the ICM7208 from TTL, a 1k-5k ohm pull-up resistor to the positive supply must be used to increase peak to peak input signal amplitude.

2. Display Considerations

Any common cathode multiplexable LED display may be used. However, if the peak digit current exceed 150 mA for any prolonged time, it is recommended that resistors be included in series with the segment outputs to limit digit current to 150mA.

The ICM7208 is specified with 500 μ A of possible digit leakage current. With certain new LED displays that are extremely efficient at low currents, it may be necessary to include resistors between the cathode outputs and the positive supply to bleed off this leakage current.

3. Display Multiplex Rate

The ICM7208 has approximately 0.5 μ s overlap between output drive signals. Therefore, if the multiplex rate is very fast, digit ghosting will occur. The ghosting determines the upper limit for the multiplex frequency reference. At very low multiplex rates flicker becomes visible.

It is recommended that the display multiplex rate be within the range of 50Hz to 200Hz, which corresponds to 400Hz to 1600Hz for the multiplex frequency reference.

4. Unit Counter

The unit counter updates the display for each negative transition of the input signal. The information on the display will count, after reset, from 00 to 9,999,999 will then reset to 000000 and begin to count up again. To blank leading zeros, actuate reset at the beginning of a count. Leading zero blanking affects two digits at a time.

For battery operated systems the display may be switched off to conserve power.

An external generator may be used to provide the multiplex frequency reference. This signal, applied to terminal 19 (terminals 16 and 20 open circuit), should be approximately equal to the supply voltage, and should be a square wave for minimum of power dissipation.

For stand alone systems, two inverters are provided so that a simple but stable RC oscillator may be built using only 2 resistors and a capacitor.

Figure 1 shows the schematic of an extremely simple unit counter that can be used for remote traffic counting, to name one application. The power cell stack should consist of 3 or 4 nickel cadmium rechargeable cells (nominal 3.6 or 4.8 volts). If 4 x 1.5 volt cells are used it is recommended that a diode be placed in series with the stack to guarantee that the supply voltage does not exceed 6 volts.

The input switch is shown to be a single pole double throw switch (SPDT). A single pole single throw switch (SPST) could also be used (with a pullup resistor), however, anti-bounce circuitry must be included in series with the counter input. In order to avoid contact bounce problems due to the SPDT switch the ICM7208 contains an input latch on chip.

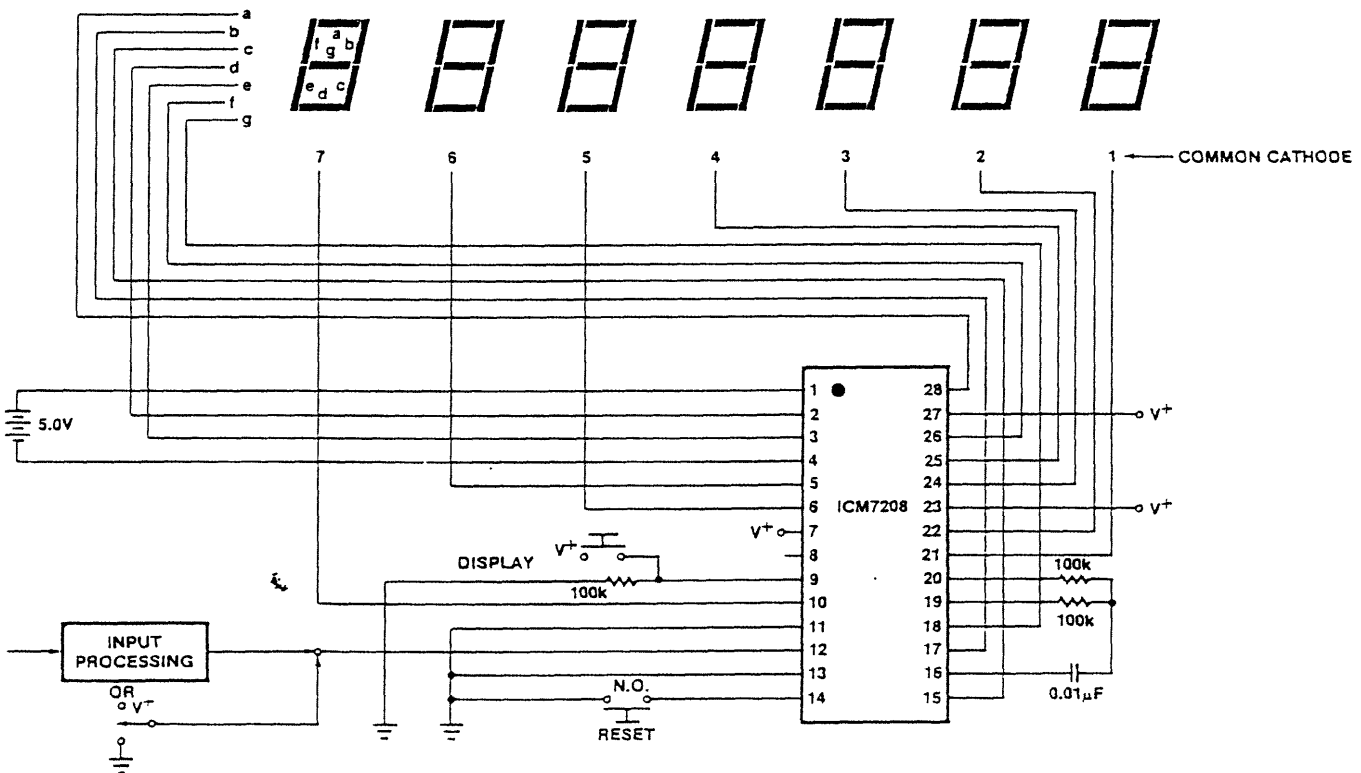

Figure 1: Schematic Unit Counter

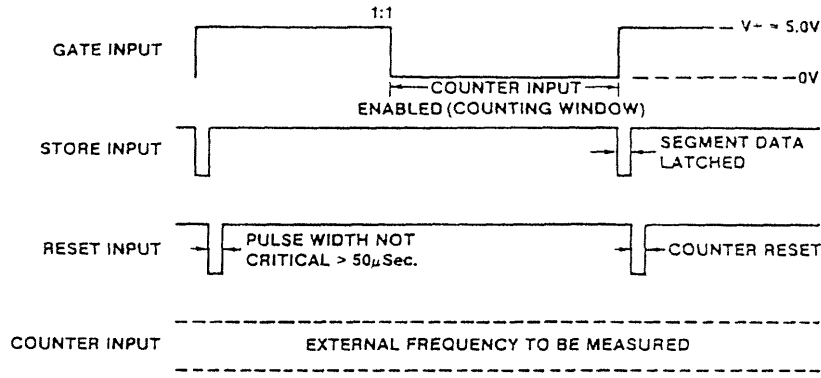

Figure 3: Frequency Counter Input Waveforms

6. Period Counter

For this application, as opposed to the frequency counter, the gating and the input signal to be measured are reversed to the frequency counter. The input period is multiplied by two to produce a single polarity signal (50% duty cycle) equal to the input period, which is used to gate into the counter the frequency reference (1MHz in this case). Figure 5 shows a

block schematic of the input waveform generator. The 1MHz frequency reference is generated by the ICM7209 Clock Generator using an 8MHz oscillator frequency and internally dividing this frequency by 8. Alternatively, a 1MHz signal could be applied directly to the 'COUNTER INPUT'. Waveforms are shown in Figure 4.

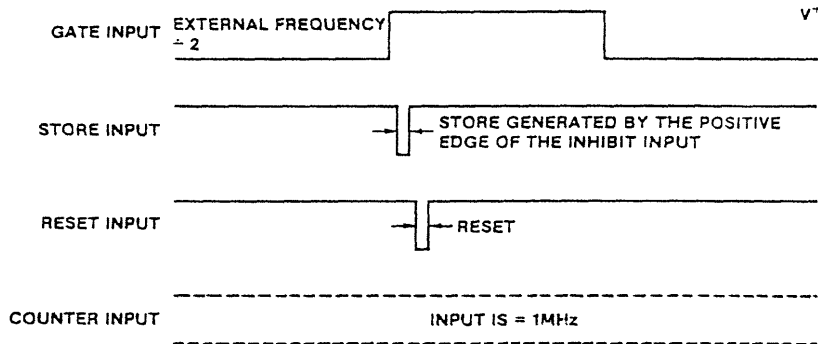

Figure 4: Period Counter Input Waveforms

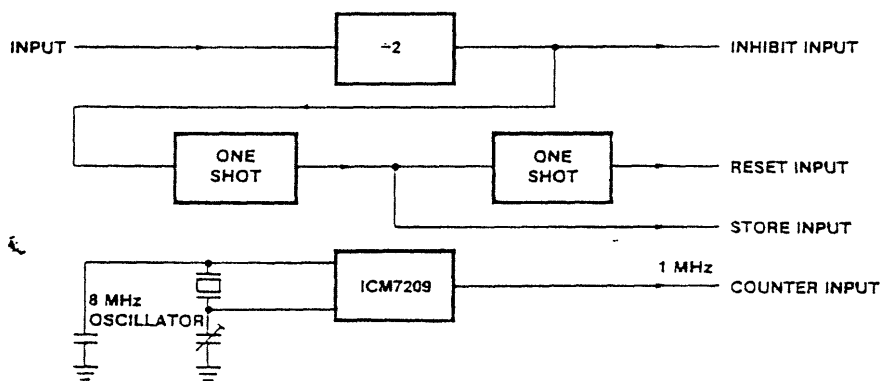
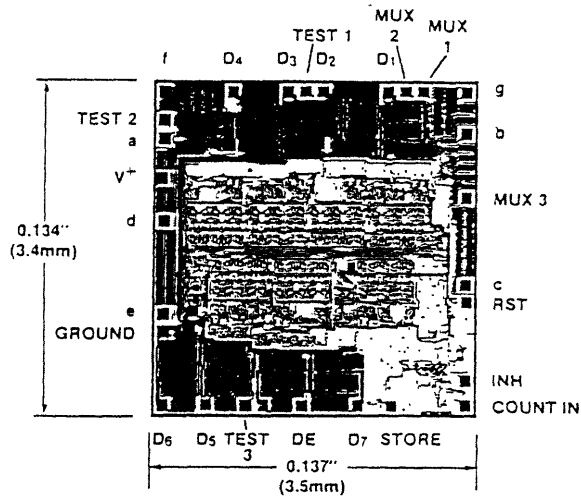
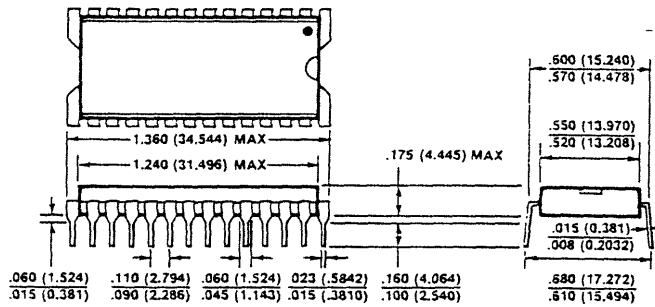

Figure 5: Period Counter Input Generator



Chip may be die attached using conventional eutectic or epoxy procedures. Wire bonding may be either aluminum ultrasonic or gold compression.

PACKAGE DIMENSIONS



10710 N. Tantau Avenue, Cupertino, CA 95014 U.S.A., Tel: (408) 996-5000, TWX: 910-338-0171
 8 Tessa Road, Richfield Trading Estate, Reading, Berks. RG1 8ND, England, Tel: 0734-595011,
 TLX: 847227 INTRSL G
 3, rue de Marly, 78000 Versailles, France, Tel: (1) 953-47-08 TLX: INTERSF 695231F
 8000 Munchen 2, Bavariaring 8, West Germany, Tel: 89/539271, TLX: 5215736 INSL D

Intersil cannot assume responsibility for use of any circuitry described other than circuitry entirely embodied in an Intersil product. No other circuit patent licenses are implied. Intersil reserves the right to change the circuitry and specifications without notice at any time.